



PREDATOR HELIOS NEO 14

USER'S MANUAL

© 2024. All Rights Reserved.

Predator Helios Neo 14

Covers: PHN14-51

This revision: March 2024



Important

This manual contains proprietary information that is protected by copyright laws. The information contained in this manual is subject to change without notice. Some features described in this manual may not be supported depending on the Operating System version. Images provided herein are for reference only and may contain information or features that do not apply to your computer. Acer Group shall not be liable for technical or editorial errors or omissions contained in this manual.

Model number: _____

Serial number: _____

Date of purchase: _____

Place of purchase: _____



The terms HDMI and HDMI High-Definition Multimedia Interface, and the HDMI Logo are trademarks or registered trademarks of HDMI Licensing Administrator, Inc. in the United States and other countries.

TABLE OF CONTENTS

First things first	6	PredatorSense	47
Your guides	6	The PredatorSense main screen....	47
Basic care and tips for using your computer	7	Widget cards	48
Turning your computer off	7	PredatorSense settings.....	50
Taking care of your computer	7	Account and Support	50
Taking care of your AC adapter	8	Planet9 website and PC client download.....	51
Cleaning and servicing	8	Scenario	52
Guidelines for safe battery usage	9	Scenario Profiles.....	52
Internal battery.....	12	System Mode	56
Taking care of your vision	12	Fan Control.....	57
Notes on using 3D images	13	Pulsar Lighting.....	58
		Adjusting the Advanced Settings.....	61
Your Predator notebook tour	14	Personal Settings.....	62
Screen view	14	Checkup	67
Keyboard view	15	Monitoring.....	69
Left view	17	App Center.....	70
USB 3.2 Gen 2 information.....	18	Securing your computer	72
USB Type-C information.....	18	Using a computer security lock.....	72
Right view	19	Using passwords.....	72
USB 3.2 Gen 2 information.....	19	Entering passwords.....	73
USB Type-C information.....	20	BIOS utility	74
Base view	20	Boot sequence.....	74
Rear view	21	Setting passwords	74
Using the keyboard	22	Power management	75
Hotkeys.....	22	Saving power	75
Special keys	23	Battery pack	77
The Windows OS Desktop	24	Battery characteristics	77
Using the Precision Touchpad	26	Charging the battery	77
Touchpad gestures	26	Optimizing battery life	78
Changing touchpad settings.....	28	Checking the battery level	79
Recovery	30	Battery-low warning.....	79
Creating a file history backup.....	30	Traveling with your computer	80
Backing up your wireless and LAN drivers.....	33	Disconnecting from the desktop ...	80
Restoring your computer.....	33	Moving around and what to bring with you.....	80
Reset this PC and keep my files.....	33	Universal Serial Bus (USB)	83
Reset this PC and remove everything	37	USB Type-C port	84
Using a Bluetooth connection	41	Thunderbolt 4 port	85
Enabling and disabling Bluetooth..	41	Displays.....	85
Enable Bluetooth and add a device.....	41	MicroSD card reader	87
Connecting to the Internet	44	Video and audio connectors	88
Connecting to a wireless network..	44	Connecting a monitor	88
Connecting to a wireless LAN.....	44	Headphones and microphone.....	88

HDMI	89		
Frequently asked questions	91		
Requesting service.....	93		
Tips and hints for using Windows	95		
Can I turn off notifications?.....	95		
Can I personalize the Lock screen?.....	95		
Can I change the screen resolution?.....	96		
Where are my apps?.....	96		
What is a Microsoft ID (account)?..	96		
How do I check for Windows updates?.....	97		
		Where can I get more information?.....	97
		Troubleshooting.....	98
		Troubleshooting tips.....	98
		Error messages.....	98
		Internet and online security	100
		First steps on the net.....	100
		Protecting your computer.....	100
		Choose an Internet Service Provider.....	100
		Network connections.....	102
		Surf the Net!.....	103
		Internet security software.....	104

Getting started...

In this section you will find:

- Useful information on caring for your computer and your health
- Where to find the power button, ports and connectors
- Windows 11 interface overview
- Tips and tricks for using the touchpad and keyboard
- How to create recovery backups
- Guidelines for connecting to a network and using Bluetooth
- Information on using Predator's bundled software

FIRST THINGS FIRST

We would like to thank you for making this Predator notebook your choice for meeting your mobile computing needs.



Warning

This product is not designed for cryptocurrency mining uses. Damages to your product arising from cryptocurrency mining or related activities are excluded from your product's warranty.

Your guides

To help you use your Predator notebook, we have designed a set of guides:

First off, the **Setup Guide** helps you get started with setting up your computer and introduces the basic features and functions of your new computer.

For more on how your computer can help you to be more productive, please refer to the **User's Manual**. This guide contains detailed information on such subjects as system utilities, data recovery, expansion options and troubleshooting.

Once you have connected to the internet, you can download updates for your computer from:

<http://go.acer.com/support>

1. The link will open the Predator Support webpage.
2. Scroll down to *Drivers and Manuals* and search for your model by pasting in or manually entering the serial number, SNID, or product model.
3. From this page you can also download and install the Predator identification utility that will automatically detect your computer's serial number and SNID and allow you to copy it to the clipboard.
4. Once you have found your product model, any updates, or documents will be listed.

Basic care and tips for using your computer

Turning your computer off

To turn the power off, do any of the following:

- Use the Windows shutdown command: Press the *Windows key* or select the *Windows Start button*, select **Power** > **Shut down**.
- Right-click the *Windows Start button* > **Shut down or sign out** > **Shut down**.

If you need to power down the computer for a short while, but don't want to completely shut it down, you can put it to *Sleep* by doing any of the following:

- Press the power button.
- Press the sleep hotkey.
- Press the *Windows key* or select the *Windows Start button*, select **Power** > **Sleep**.
- Right-click the *Windows Start button* > **Shut down or sign out** > **Sleep**.



Note

If you cannot power off the computer normally, press and hold the power button for up to ten seconds to shut down the computer. If you turn off the computer and want to turn it on again, wait at least two seconds before powering up.

Taking care of your computer

Your computer will serve you well if you take care of it.

- Only use the adapter provided with your device, or an Acer-approved adapter to power your device.
- Do not expose the computer to direct sunlight. Do not place it near sources of heat, such as a radiator.
- Do not expose the computer to temperatures below 0° C (32° F) or above 50° C (122° F).
- Do not subject the computer to magnetic fields.

- Do not expose the computer to rain or moisture.
- Do not spill water or any liquid on the computer.
- Do not subject the computer to heavy shock or vibration.
- Do not expose the computer to dust or dirt.
- Never place objects on top of the computer.
- Do not slam the computer display when you close it.
- Never place the computer on uneven surfaces.

Taking care of your AC adapter

Here are some ways to take care of your AC adapter:

- Do not connect the adapter to any other device.
- Do not step on the power cord or place heavy objects on top of it. Route the power cord and any cables away from where people walk.
- When unplugging the power cord, do not pull on the cord itself but pull on the plug.
- The total ampere ratings of the equipment plugged in should not exceed the ampere rating of the cord if you are using an extension cord. Also, the total current rating of all equipment plugged into a single wall outlet should not exceed the fuse rating.

Cleaning and servicing

When cleaning the computer, follow these steps:

1. Turn off the computer.
2. Disconnect the AC adapter.
3. Use a soft, moist cloth. Do not use liquid or aerosol cleaners.

If your computer is dropped or visibly damaged, or does not work normally, please contact your nearest authorized Acer service center.

Guidelines for safe battery usage



Warning

When using a charging cart or a small space to simultaneously charge or operate multiple devices, the area must be well-ventilated and the temperature kept between 0 °C (32 °F) to 35 °C (95 °F) and battery charging must be stopped when 100% capacity is reached.

Continuous charging can cause deformation or damage to the battery/device.

Precautions when charging batteries

The useful lifespan of a battery is adversely affected by the following behavior:

- Constantly charging the battery/device when already at full capacity.
- Charging the battery/device at temperatures above 35 °C (95 °F) or below 0 °C (32 °F).

To prevent damage, follow these precautions:

- Stop charging the battery once it reaches 100% capacity; regularly or frequently charging a fully charged battery for an extended period of time may cause battery deformation or damage. We recommend that you recharge the device when the battery level drops below 70% capacity.
- Do not charge battery in temperatures above 35 °C (95 °F) or below 0 °C (32 °F). Charging in abnormally high or abnormally low temperatures can cause battery deformation or damage.
- The charging port must be clean and free from debris and should only be used with Acer charging equipment. Use of a non-Acer battery or charging equipment can cause damage to the product and will void the warranty.
- If you plan to store the device for a long period of time, turn-off the device, remove AC power and store the product at room temperature (0 °C - 35 °C) in a dry (humidity: 45% - 80%), well-ventilated area. Avoid direct sunlight, high temperatures and high humidity. Do not

leave your device's battery completely discharged for a long period of time; this may cause battery deformation or damage. We recommend that the battery is checked and charged to approximately 50% capacity every 6 months.

- ONLY CHARGE THE BATTERY IN A CLEAN, WELL VENTILATED AREA.



Warning

**Batteries may explode if not handled properly.
Do not disassemble or dispose of batteries in fire.
Do not short external contacts, crush, puncture or otherwise tamper with batteries. Keep batteries away from children.
Follow local regulations when disposing of used batteries.**

Precautions when replacing the battery

Improper replacement or mishandling could damage the battery, cause overheating, result in injury, and risk fire or explosion.

- Device with built-in battery: A built-in battery must be replaced by an authorized service center. Do not attempt to replace or remove the battery by yourself.
- Device with removable battery: The battery should only be replaced with parts approved by Acer. Do not replace the battery with any parts other than approved ones.

This notebook uses a Lithium-based battery. Do not use it in a humid, wet or corrosive environment. Do not put, store or leave your product in or near a heat source, in a high temperature location, in strong direct sunlight, in a microwave oven or in a pressurized container, and do not expose it to temperatures over 50 °C [122 °F].

Failure to follow these guidelines may cause the battery to leak acid, become hot, explode or ignite and cause injury and/or damage. Do not pierce, open or disassemble the battery. If the battery leaks and you come into contact with the leaked fluids, rinse thoroughly with water and seek medical attention immediately. For safety reasons, and to prolong the lifetime of the battery, charging will must not

occur at temperatures below 0 °C (32 °F) or above 35 °C (95 °F).

The full performance of a new battery is achieved only after two or three complete charge and discharge cycles. The battery can be charged and discharged hundreds of times, but it will eventually wear out. When the operation time becomes noticeably shorter than normal, check an authorized reseller to purchase a new battery.

Use the battery only for its intended purpose. Never use any charger or battery that is damaged. Do not short-circuit the battery. Accidental short-circuiting can occur when a metallic object such as a coin, clip or pen causes direct connection of the positive (+) and negative (-) terminals of the battery. (These look like metal strips on the battery.) This might happen, for example, when you carry a spare battery in your pocket or purse. Short-circuiting the terminals may damage the battery or the connecting object.

The capacity and lifetime of the battery will be reduced if the battery is left in hot or cold places, such as in a closed car in summer or winter. Always try to keep the battery between 15° C and 25° C (59° F and 77° F). A device with a hot or cold battery may not work temporarily, even when the battery is fully charged. Battery performance is especially limited in temperatures well below freezing.

Do not dispose of batteries in a fire as they may explode. Batteries may also explode if damaged. Dispose of batteries according to local regulations. Please recycle when possible. Do not dispose as household waste.

Wireless devices may be susceptible to interference from the battery, which could affect performance.

**Note**

Please refer to www.acer.com for battery shipping documents.

Internal battery

- Do not attempt to replace a built-in rechargeable battery, battery replacement must be done by an Acer- authorized repair facility.

Recharge the battery by following the instruction included in the product documentation.

Taking care of your vision

Long viewing hours, wearing incorrect glasses or contact lenses, glare, excessive room lighting, poorly focused screens, very small typefaces and low-contrast displays could stress your eyes. The following sections provide suggestions on how to reduce eyestrain.

- Eyes
 - Rest your eyes for 5-10 minutes for every one hour of using the product.
 - Give your eyes regular breaks by looking away from the monitor and focusing on a distant point.
 - Blink frequently to keep your eyes from drying out.
- Display
 - Keep your display clean.
 - Keep your head at a higher level than the top edge of the display so your eyes point downward when looking at the middle of the display.
 - Adjust the display brightness and/or contrast to a comfortable level for enhanced text readability and graphics clarity.
- Eliminate glare and reflections by:
 - placing your display in such a way that the side faces the window or any light source,
 - minimizing room light by using drapes, shades or blinds,
 - using a task light,
 - changing the display's viewing angle,
 - using a glare-reduction filter,

- using a display visor, such as a piece of cardboard extended from the display's top front edge.
- Avoid adjusting your display to an awkward viewing angle.
- Avoid looking at bright light sources for extended periods of time.

Notes on using 3D images

- You may experience motion sickness like symptoms or fatigue depending on your physique or physical condition during or after viewing 3D images. If you feel unwell or tired, please stop using it immediately and take a rest.
- If the left and right eyes have a different vision or tend to use one eye to see things, it will be difficult to see clear 3D images and easy to feel tired. Please take appropriate rest and pay attention to your physical condition.

YOUR PREDATOR NOTEBOOK TOUR

After setting up your computer as illustrated in the Setup Guide, let us show you around your new Predator computer.

Screen view

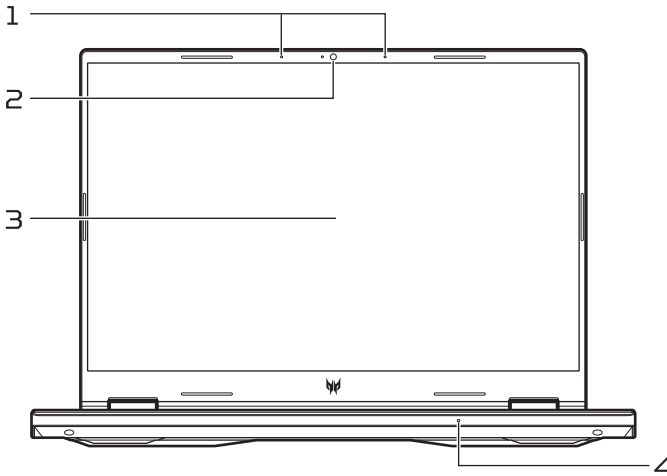

#	Icon	Item	Description
1		Microphones	Internal digital microphones for sound recording.
2		Webcam	Web camera for video communication. <i>A light next to the webcam indicates that the webcam is active.</i>
3		Screen	Displays computer output.
4		Microphone	Internal digital microphone for sound recording with AI noise reduction function.





Note

This monitor uses low blue light panel. When the monitor is default setting (Preset mode: Standard), it works in compliance with TÜV Rheinland. The Low Blue Light feature on the display is designed to minimize blue light emitted from the display for better eye comfort.

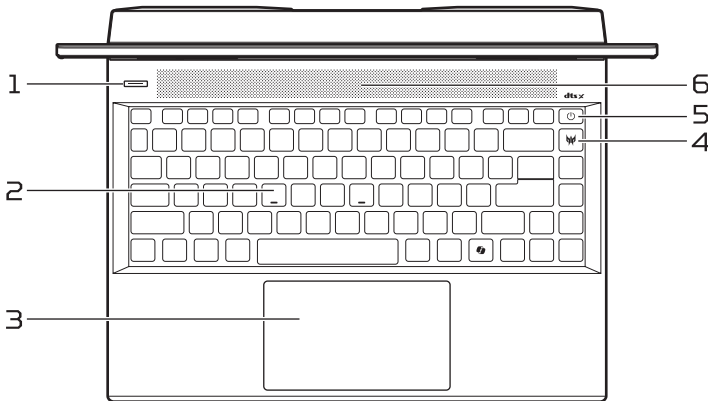
Keyboard view



#	Icon	Item	Description
1		Mode key	Switches to different modes in turns.
2		Keyboard	For entering data into your computer. <i>See "Using the keyboard" on page 22.</i>

#	Icon	Item	Description
3		Touchpad	Touch-sensitive pointing device. <i>The touchpad and selection buttons form a single surface. Press down firmly on the touchpad surface to perform a left click. Press down firmly on the lower right corner to perform a right click.</i>
4		PredatorSense key	Launches PredatorSense application.
5		Power button	Turns the computer on and off.
6		Ventilation and cooling fan	Allows the computer to stay cool. <i>Do not cover or obstruct the openings.</i>









Note

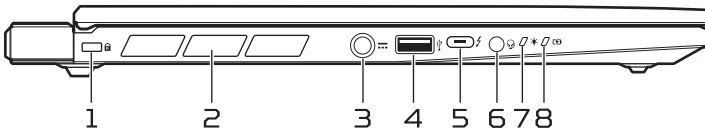

key: Feature availability varies by market, see aka.ms/WindowsAIFeatures

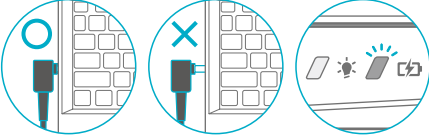
Left view



#	Icon	Item	Description
1		Kensington lock slot	Connects to a Kensington-compatible security lock.
2		Ventilation and cooling fan	Allows the computer to stay cool. <i>Do not cover or obstruct the openings.</i>
3		DC-in jack	Connects to an AC adapter.
<p>Note: Please press the AC adapter into the tunnel to the power connector. You will feel a click indicating it is connected. Then, check the light of battery indicator shows amber while charging.</p>			
			
4		USB port	Connects to USB devices.
5		USB Type-C / Thunderbolt 4 port	Connects to USB devices with a USB Type-C connector. Supports Thunderbolt™ 4 and displays.
6		Headset/speaker jack	Connects to audio devices (e.g., speakers, headphones) or a headset with microphone.
7		Power indicator	Indicates the computer's power status.

#	Icon	Item	Description
8		Battery indicator	Indicates the computer's battery status. <i>Amber when the battery is charging.</i> <i>Blue when fully charged (with the AC adapter plugged in).</i>

USB 3.2 Gen 2 information

- USB 3.2 Gen 2 compatible port(s): blue.
- Compatible with USB 3.2 Gen 2 and earlier devices.
- For optimal performance, use USB 3.2 Gen 2-certified devices.
- Defined by the USB 3.2 Gen 2 specification (SuperSpeed USB).

USB Type-C information

- USB 3.2 Gen 2 with transfer speeds up to 10 Gbps.
- Supports DisplayPort™ audio/video output.
- Compatible with Thunderbolt™ 4.
- Delivers up to 3 A at 5 V DC for USB charging.
- DC-in: requires power adapter or power source providing 65 W at 20 V.
For optimal performance, please use a certified Acer power adapter or USB Power Delivery device.





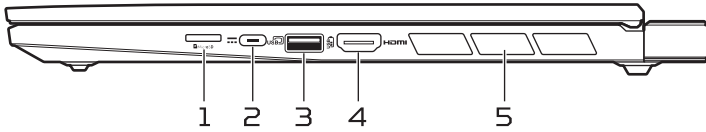

Note

Specifications vary depending on model or Operating System.

Right view



#	Icon	Item	Description
1		MicroSD card reader	Accepts one Secure Digital [microSD] card. <i>Only one card can operate at a time.</i>
2		USB Type-C port with DC-in	Connects to the USB Type-C power adapter and to USB devices with a USB Type-C connector. Supports DisplayPort™ over USB-C™.
3		USB port with power-off charging	Connects to USB devices.
4		HDMI 2.1 port	Supports high-definition digital video connections.
5		Ventilation and cooling fan	Allows the computer to stay cool. <i>Do not cover or obstruct the openings.</i>

USB 3.2 Gen 2 information

- USB 3.2 Gen 2 compatible port(s): blue.
- Compatible with USB 3.2 Gen 2 and earlier devices.
- For optimal performance, use USB 3.2 Gen 2-certified devices.
- Defined by the USB 3.2 Gen 2 specification [SuperSpeed USB].

USB Type-C information

- USB 3.2 Gen 2 with transfer speeds up to 10 Gbps.
- Supports DisplayPort™ audio/video output.
- Compatible with Thunderbolt™ 4.
- Delivers up to 3 A at 5 V DC for USB charging.
- DC-in: requires power adapter or power source providing 65 W at 20 V.

For optimal performance, please use a certified Acer power adapter or USB Power Delivery device.

Base view

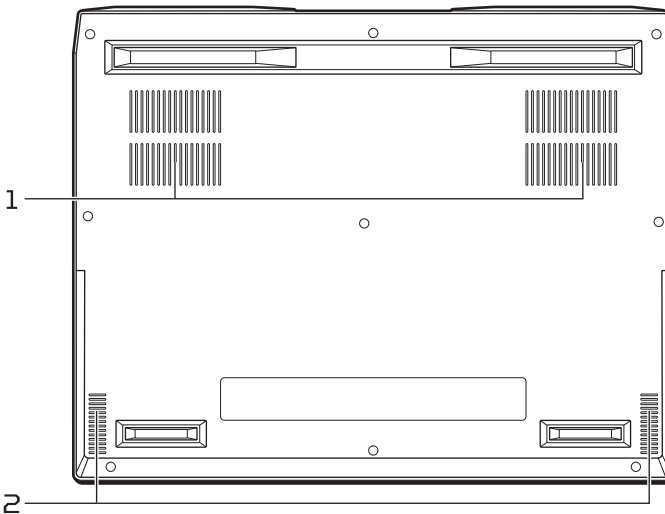

#	Icon	Item	Description
1		Ventilation and cooling fan	Allows the computer to stay cool. <i>Do not cover or obstruct the openings.</i>
2		Speakers	Deliver stereo audio output.

Rear view

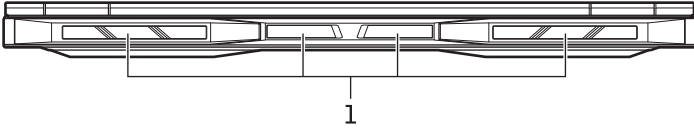











#	Icon	Item	Description
1		Ventilation and cooling fan	Allows the computer to stay cool. <i>Do not cover or obstruct the openings.</i>







USING THE KEYBOARD

The keyboard has full-sized keys, a numeric keypad, separate cursor, lock, Windows keys and hotkeys.

Hotkeys

To activate hotkeys, press and hold the Fn key before pressing the other key in the hotkey combination.

Hotkey	Icon	Function	Description
Fn + F1		Speaker toggle	Turns the speakers on and off.
Fn + F2		Volume down	Decreases the sound volume.
Fn + F3		Volume up	Increases the sound volume.
Fn + F4		Lock your computer	Locks your computer to secure your information. You can enter password to continue your work.
Fn + F5		Brightness down	Decreases the screen brightness.
Fn + F6		Brightness up	Increases the screen brightness.
Fn + F7		Display toggle	Switches display output between the display screen, external monitor (if connected) and both.
Fn + F8		Microphone toggle	Turns the microphones on and off.
Fn + F9		Flight mode	Turns on / off the computer's network devices.
Fn + F10		Touchpad toggle	Turns the built-in touchpad on and off.

Hotkey	Icon	Function	Description
Fn + F11		Keyboard backlight decrease	Decreases the intensity of the keyboard backlight.
Fn + F12		Keyboard backlight increase	Increases the intensity of the keyboard backlight.
Fn + PrtSc		Snipping Tool	Snips a rectangle, freeform, window or full screen to your clipboard.
Fn + ▶/ 		Microphone toggle	Turns the microphones on and off.
Fn + ▶	End	End	Scrolls to the end of a document.
Fn + ◀	Home	Home	Scrolls to the beginning of a document.
Fn + ▲	Pg Up	Page up	Scrolls the page up.
Fn + ▼	Pg Dn	Page down	Scrolls the page down.
Fn + 		Windows key lock toggle	Turns on / off the Windows key lock.

Special keys

Your computer's keyboard includes keys that activate special functions. The function of each key is clearly marked with an icon.

Icon	Function	Description
PrtSc	Print Screen	Take quick screen shots.
▶/	Play/Pause	Plays or pauses a selected media file.
◀◀	Previous	Returns to the previous media file.
▶▶	Next	Jumps to the next media file.

THE WINDOWS OS DESKTOP

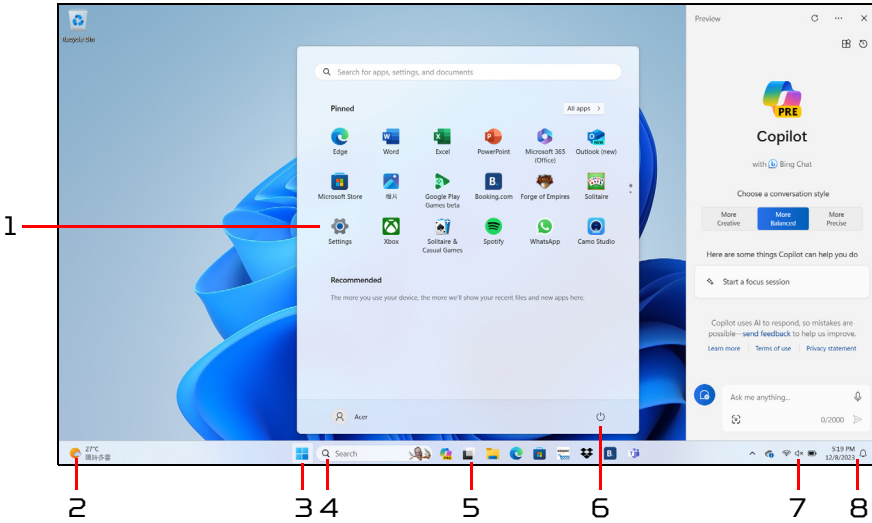

Note

Screen simulated, subject to change. Feature availability and rollout timing varies by market and device.

#	Item	Description
1	Settings	Changes the apps settings for your computer.
2	Widgets	Provides the weather, news, stocks, and sports information.
3	Start	Launches apps, through Pinned, Recommended, or All apps.
4	Search	Types in the texts to search on your computer and the Internet.
5	Task View	Allows to switch between running applications and add the virtual desktop.
6	Power	Shut down, sleep or restart your computer.

#	Item	Description
7	Quick settings	Displays the situation of network connection, battery level and sound setting. You can toggle quick actions to instantly adjust or open settings.
8	Notification	Displays the notifications and calendar.

USING THE PRECISION TOUCHPAD

The touchpad controls the arrow  (or 'cursor') on the screen. As you slide your finger across the touchpad, the cursor will follow this movement. The Precision Touchpad (PTP) is designed to provide a more uniform, smooth, and accurate touchpad experience. Many applications support precision touchpad gestures that use one or more fingers, however, some gestures may not be supported by the specific application or program you are using.

Touchpad gestures

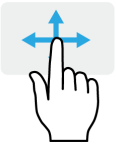

Single-finger slide

Slide a finger across the touchpad to move the cursor.



Single-finger press or tap

Press the touchpad down, or lightly tap the touchpad with your finger, to perform a 'click', which will select or start an item. Quickly repeat the tap to perform a double tap or 'double click'.



Two-finger press

Lightly tap the touchpad with two fingers to perform a  'right click'. In the *Start* screen, this will toggle the app commands. In most apps this will open a context menu related to the selected item.

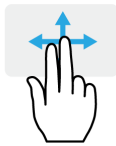

Two-finger slide

Swiftly scroll through web pages, documents and playlists by placing two fingers on the touchpad and moving both in any direction.



Two-finger pinch

Zoom in and out of photos, maps and documents with a simple finger-and-thumb gesture.



Three-finger press

Lightly tap the touchpad with three fingers to open the *Search Windows*.

Three-finger swipe

Swipe across the touchpad with three fingers.

- Swipe up to open *Task View*. Move the cursor over a window and tap the touchpad to select that window, or swipe downwards to exit *Task View*.
- Swipe down to minimize all open windows and show *Desktop*; swipe upwards to restore the minimized windows.
- Swipe right to switch between open windows.



Four-finger press

Lightly tap the touchpad with four fingers to open the Notifications and Calendar.

Four-finger swipe

Swipe across the touchpad with four fingers.

- Swipe up to open *Task View*. Move the cursor over a window and tap the touchpad to select that window, or swipe downwards to exit *Task View*.
- Swipe down to minimize all open windows and show *Desktop*; swipe upwards to restore the minimized windows.



The precision touchpad includes added technology features that help recognize and prevent unintentional gestures such as accidental taps, gestures, and pointer movement.



Note

The touchpad is sensitive to finger movement; the lighter the touch, the better the response. Please keep the touchpad and your fingers dry and clean.

Changing touchpad settings

To change the touchpad settings to suit your personal requirements, please do the following.

1. In the icon tray in the lower right-hand corner of the screen, select the *Network, Sound and Battery* icon to open the *Quick settings* pane.



2. Select **All settings**.



3. Select **Bluetooth & devices > Touchpad**



4. Now you can adjust the settings to suit your personal needs. You can switch off the touchpad if you prefer to use

a mouse. Or you can adjust the touchpad sensitivity to suit your needs. Scroll down to see more settings.

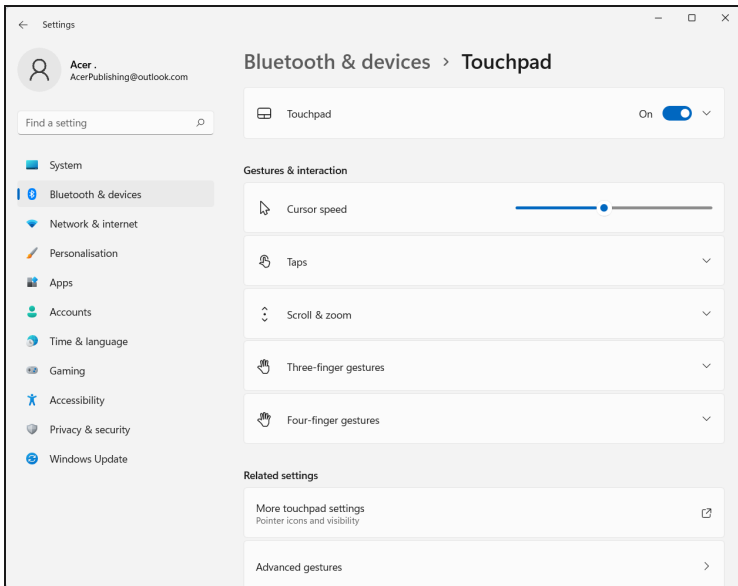

RECOVERY

If you are having trouble with your computer, and the frequently asked questions (**see Got a question? on page 90**) do not help, you can recover your computer.

This section describes the recovery tools available on your computer. Predator provides *Acer Care Center*, which allows you to reset your PC, refresh your PC, backup files/data or create a factory default backup. If you cannot access *Acer Care Center*, click **Settings** in the Start menu, select **System** > **Recovery**.



Note

Acer Care Center vary depending on model or Operating System.

Creating a file history backup

Recovery Management allows you to quickly and easily back up your files and restore them if the originals are lost, damaged or deleted.

1. From *Start*, select **Care Center** in **All apps** list then **Recovery Management**.
2. Select the *Backup* tab and click **Get started** for *Create backup* to open the *Backup* window.

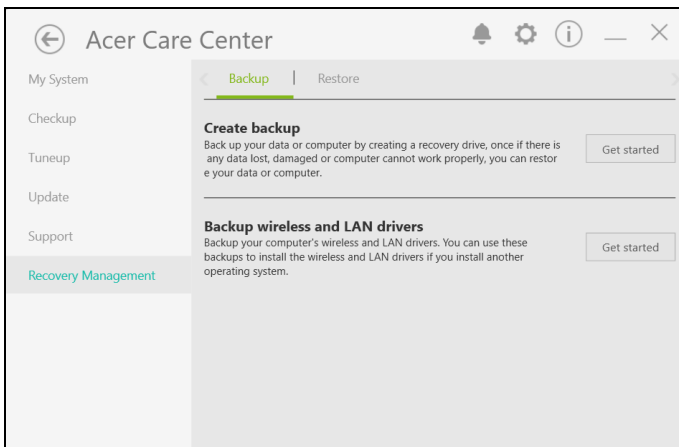

3. Click **Set up syncing** for *OneDrive folder syncing* to continue.

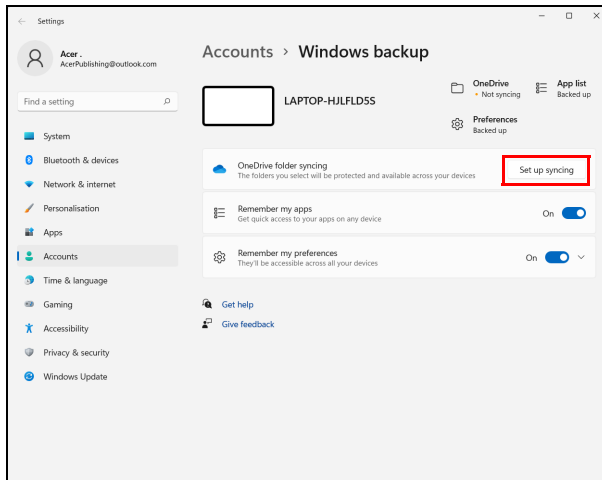

4. Make sure the folders that you want to back up are selected and click **Start back up** to continue.

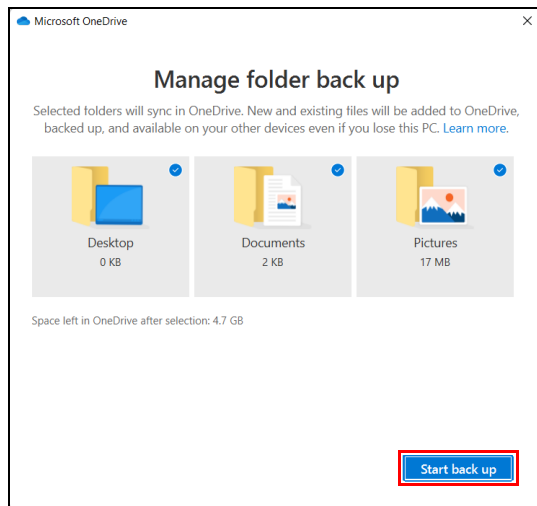

5. You can select **View sync progress** to watch files sync until it completes.

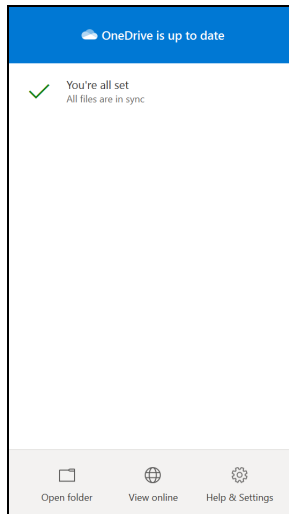
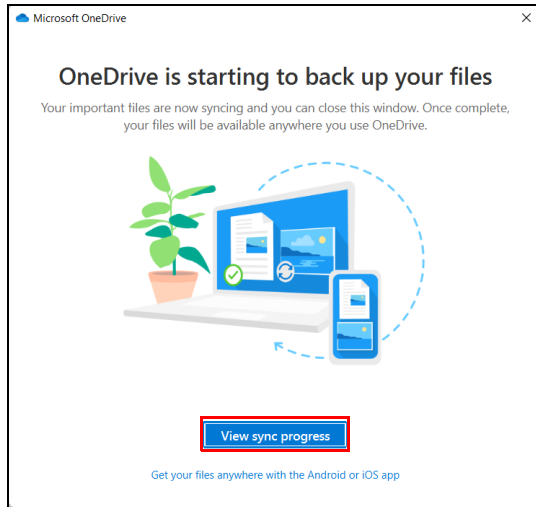

6. To open the OneDrive folder, double click **OneDrive** icon in the notification area.

Backing up your wireless and LAN drivers

Back up your wireless and LAN drivers. You can use these backups to install the wireless and LAN drivers if you install another operating system.

1. From *Start*, select **Care Center** in **All apps** list then **Recovery Management**.
2. Select the *Backup* tab and click **Get started** for *Backup wireless and LAN drivers*. Choose a folder to save your drivers and select **OK**.
3. You will be shown the backup progress on the screen.

Restoring your computer

Recovery Management allows you to quickly and easily restore your computer back to its default status. You can choose to keep your files or remove them before reinstalling Windows.

Reset this PC and keep my files

1. From *Start*, select **Care Center** in **All apps** list then **Recovery Management**.
2. Select the *Restore* tab and click **Get started** to open the *Recovery* window.

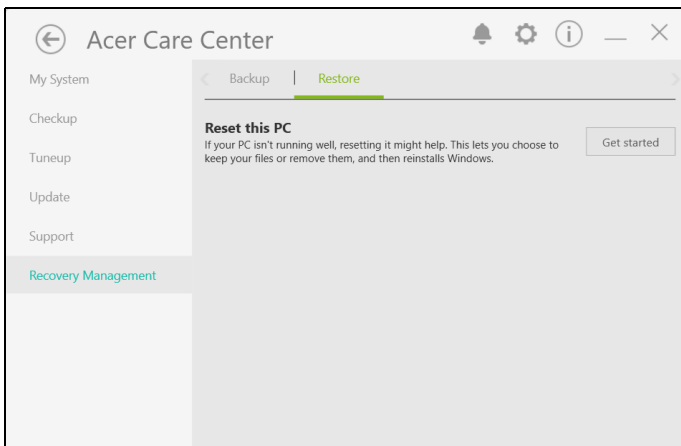

3. Click **Reset PC** to *Choose an option*.

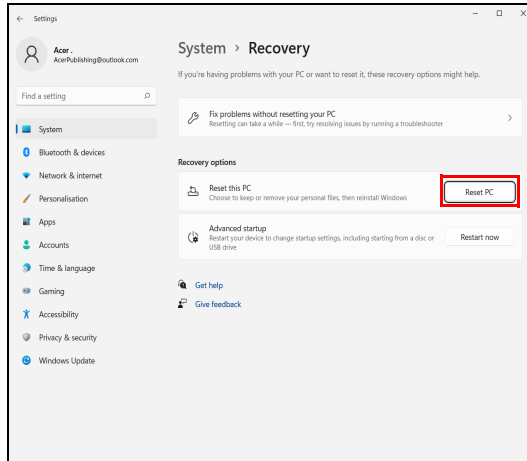

4. Select **Keep my files** to refresh your PC and reinstall your operating system without removing your personal files.

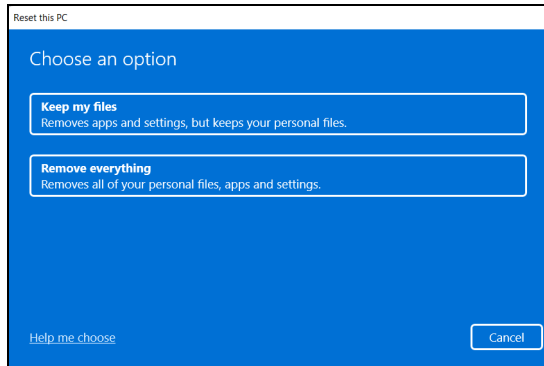

5. Choose from the two options - **Cloud download** or **Local reinstall** to reinstall Windows. (Ensure you are connected to the internet when using Cloud download.)

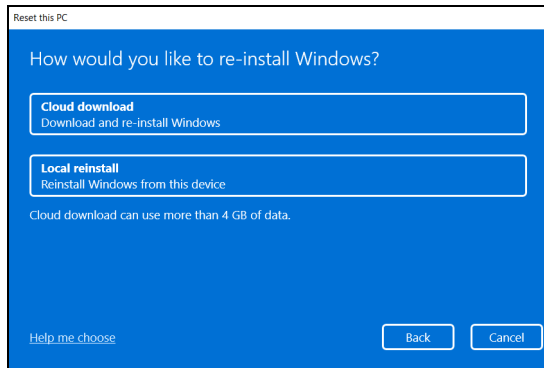

6. Click **Change settings** to open the *Choose settings* options.

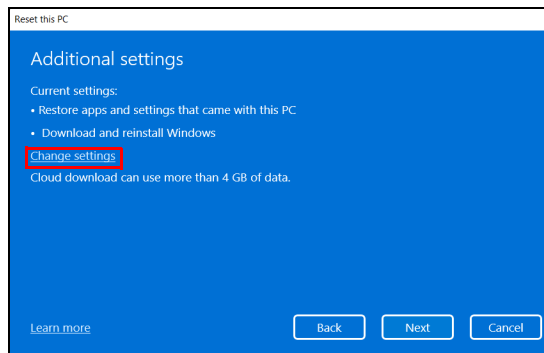

7. Choose your settings options and follow the instructions on screen. Click **Confirm** then **Next** to continue.

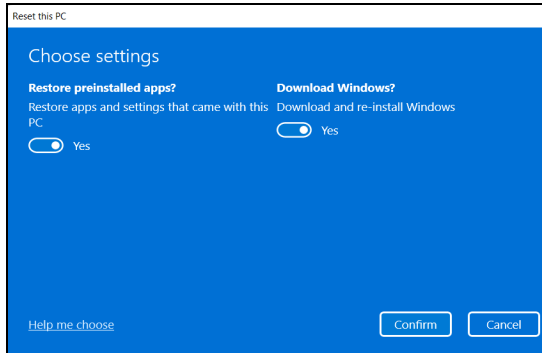

Important

If you have apps installed on your PC, they will be removed.

8. Resetting the PC will reinstall Windows, change settings back to their factory defaults and remove all preinstalled apps and programs without removing your personal files. Click **Reset** to continue. This will take a while and your PC will restart.

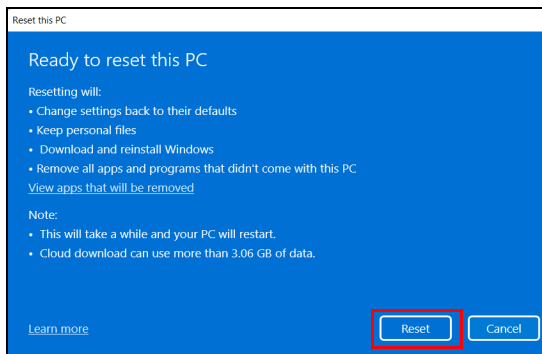

9. You will be shown the reset progress on the screen. The screen will turn off during the reset process.
10. The screen will turn back on when it is installing Windows. Your PC will restart several times during the reset process.

11. Follow the process until it completes.
12. When your PC has completed the reset process, Windows will have been reset back to its factory default settings without removing your personal files.

Reset this PC and remove everything

1. From *Start*, select **Care Center** in **All apps** list then **Recovery Management**.
2. Select the *Restore* tab and click **Get Started** to open the *Recovery* window.

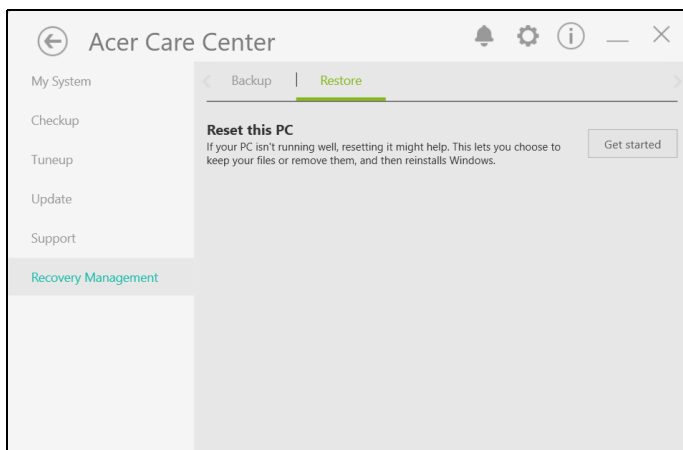

3. Click **Reset PC** to *Choose an option*.

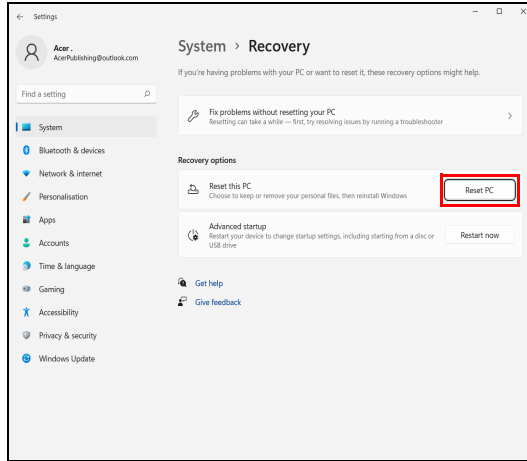

4. Select **Remove everything** to reset your PC back to its factory default.

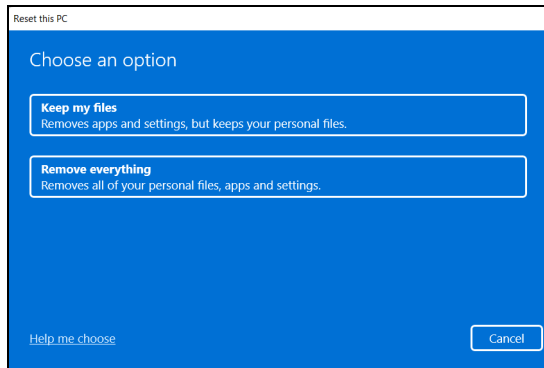

5. Choose from the two options - **Cloud download** or **Local reinstall** to reinstall Windows. (Ensure you are connected to the internet when using Cloud download.)

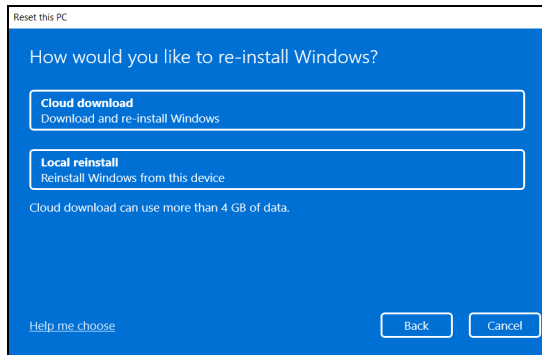

6. Click **Change settings** to open the *Choose settings* options.

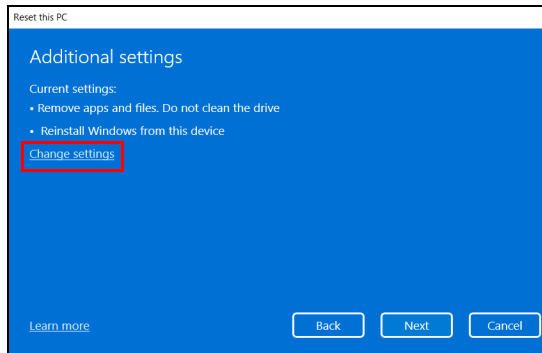

7. Choose your settings options and follow the instructions on screen. Click **Confirm** then **Next** to continue.

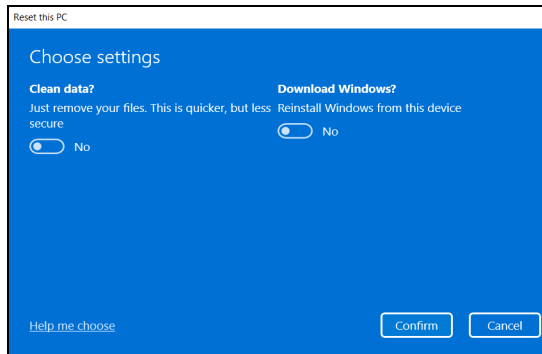

8. Click **Reset** to continue.

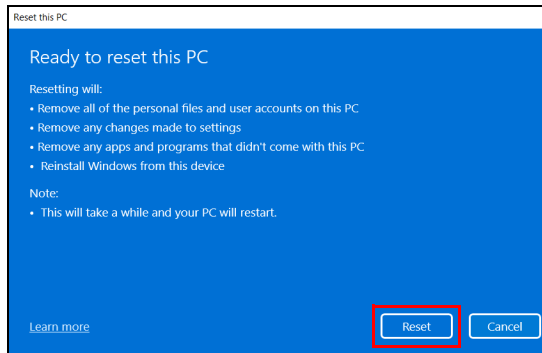

9. You will be shown the reset progress on the screen. The screen will turn off during the reset process.
10. The screen will turn back on when it is installing Windows. Your PC will restart several times during the reset process.
11. Follow the process until it completes.
12. When your PC has completed the reset process, Windows will use factory default settings.

USING A BLUETOOTH CONNECTION

Bluetooth is a technology enabling you to transfer data wirelessly over short distances between many different types of devices. Bluetooth-enabled devices include computers, cell phones, tablets, wireless headsets, and keyboards.

To use Bluetooth, you must ensure the following:

1. Bluetooth is enabled on both devices.
2. Your devices are "paired" (or connected).

Enabling and disabling Bluetooth

The Bluetooth adapter must be enabled on both devices. For your computer, this may be an external switch, a software setting, or a separate Bluetooth dongle plugged into the computer's USB port (if no internal Bluetooth adapter is available).



Note

Please check your devices owner's manual to determine how to turn on its Bluetooth adapter.

Enable Bluetooth and add a device

Every new device must first be "paired" with your computer's Bluetooth adapter. This means it must first be authenticated for security purposes. You only need to pair once. After that, simply turning on the Bluetooth adapter of both devices will connect them.

Bluetooth on your computer is disabled by default. To enable your computer's Bluetooth adapter, do the following:

1. Press the *Windows* key or select the *Windows Start button* > **Settings** > **Bluetooth & devices**, and click the toggle under **Bluetooth** to enable/disable it.

2. Click on **Add device** then select the device that you want to add.
3. Your computer will automatically start searching for devices, as well as make itself visible to other devices.
4. Select the device you wish to pair from the list of discovered devices.

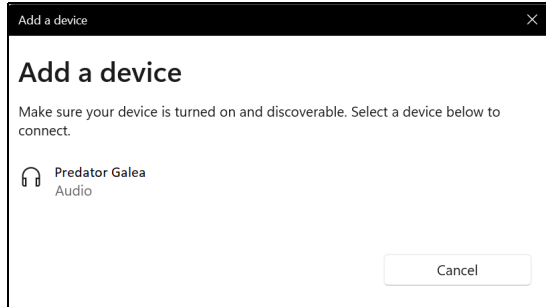

5. After pairing, if there is a code displaying on the screen, enter that code on the device to proceed the connection.

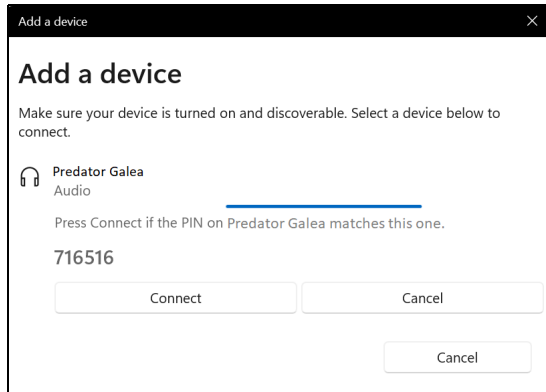

Note

Some devices using older versions of the Bluetooth technology require both devices to enter a PIN. In the case of one of the devices not having any inputs (as in a headset), the passcode is hardcoded into the device (usually "0000" or "1234"). Consult your device's user manual for more information.

You can also enter the Bluetooth settings by selecting the *Network, Sound and Battery* icon in the lower right-hand corner of the screen to open the *Quick settings* pane. From here, you can enable or disable Bluetooth or right-click on **Bluetooth > Go to Settings** to enter the Bluetooth settings.

CONNECTING TO THE INTERNET

This chapter includes general information on types of connections, and getting connected to the internet. For detailed information, please refer to **Network connections on page 131**.

Your computer's built-in network features make it easy for you to connect your computer to the internet.

First though, in order to connect to the internet from home, you'll need to sign up for internet services from an ISP (Internet Service Provider) -- usually a phone or cable company -- that will have to go to your home or office to set up internet service. The ISP will install a small box, a router or modem, that will allow you to connect to the internet.

Connecting to a wireless network

Connecting to a wireless LAN

A wireless LAN (or WLAN) is a *wireless local area network*, which can link two or more computers without using wires. Once connected to WLAN, you can access the internet. You can also share files, other devices, and even your internet connection itself.

Your computer's wireless connection is turned on by default and Windows will detect and display a list of available networks during setup. Select your network and enter the password if required.



Warning

Using wireless devices while flying in aircraft may be prohibited. All wireless devices must be switched off before boarding an aircraft and during take-off, as they may be dangerous to the operation of the aircraft, disrupt communications, and even be illegal. You may turn on your computer's wireless devices only when informed that it is safe to do so by the cabin crew.

Predator computers feature a *Flight mode* hotkey that turns the network connection on or off. You can use the network management options to turn your wireless network on/off or control what is shared over the network.

To connect to a wireless network, please follow the steps below.

1. Ensure you have a wireless router/access point and current internet connection through the ISP of your choice. Make a note of the wireless network's name and password (if necessary). If you are trying to connect to a public network (such as at a coffeeshop), make sure you have the wireless network's name.



Note

Please refer to your ISP or router documentation for details on connecting to the internet.

2. Click **Network** icon in the notification area.



3. Select *Manage WiFi connections*.

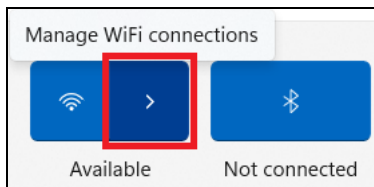

Note

*If Wi-Fi is turned off, please click **Wi-Fi** icon to turn it on.*

4. You will see a list of available wireless networks. Select the one you wish to use.

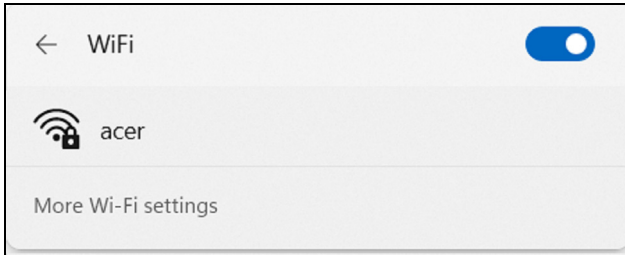

5. Once you select a wireless network, select **Connect**.

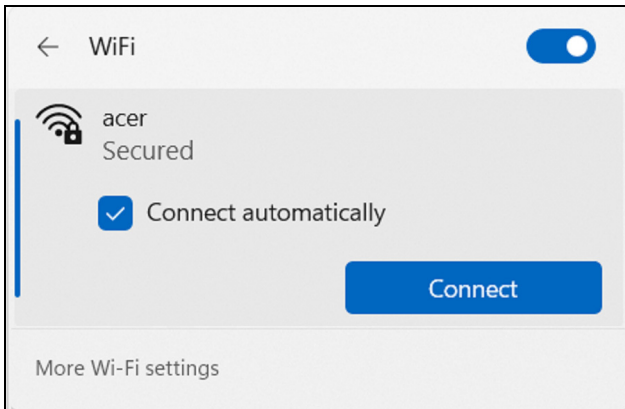

6. If required, enter the network's password.

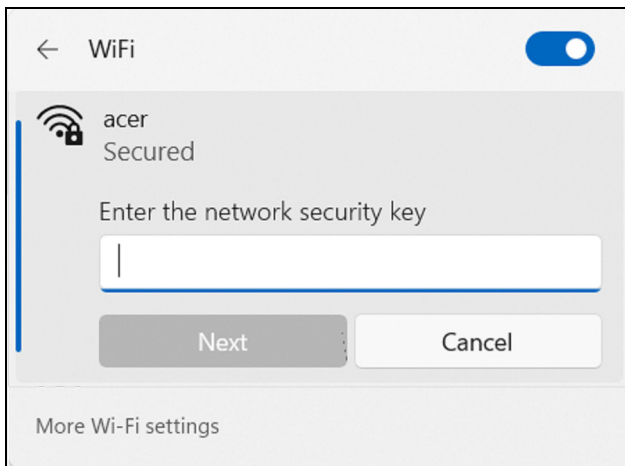

PREDATORSENSE

PredatorSense allows you to fine-tune several parameters related to power consumption and conduct quick-check on health of battery, storage, and RAM. In addition, *PredatorSense* also empowers users to switch operating modes, control fan behavior, select sound effects, and delicately customize pulsar lighting settings. You can personalize the lighting effect of the keyboard by different color effects, either dynamic or static, and by distinct zones, areas underneath each keycap or preselected zones. Each function can be done individually or collectively through constructing scenario profiles, which enable the synchronization with the associated apps.

Quick-access to switching scenarios, monitoring system performance, checking live updates, and the apps are available through the widget cards.



Note

Function varies depending on configuration.

The *PredatorSense* main screen

The **Home** screen provides an one-glance overview of system performance and temperatures. It also dynamically displays the current system mode with live 3D avatar that accurately reflect the operational status.

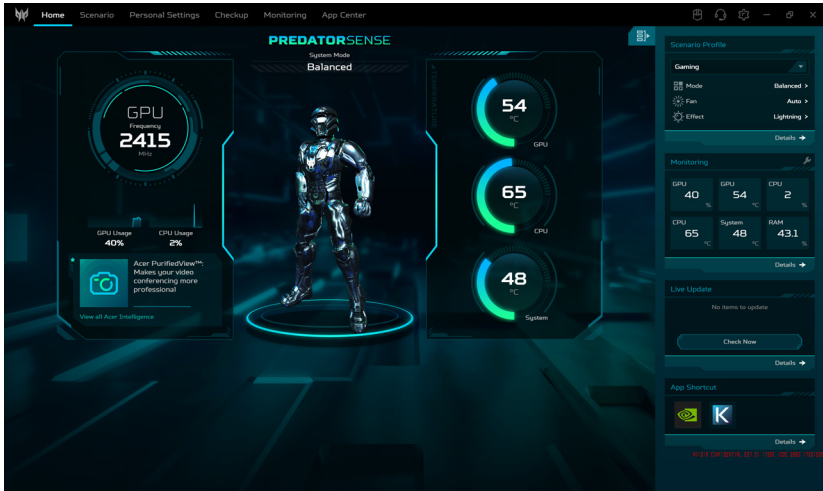

Note

The performance parameters and temperatures listed may vary depending on your computer's configuration and the power output of the CPU and GPU.

Widget cards

Widget cards are always visible on all *PredatorSense* screens by default. If they are hidden, click the *Widget* icon



- In the **Scenario Profile** tab, you can select your preferred scenario profile which is differentiated by operating mode, performance of the fans, and lighting effect. For more detailed information of available profiles, simply select **Details** to access the **Scenario Manager**.

- Under the **Monitoring** tab, you can view system performance. To customize the view, click the *Adjust* icon  and select the items you want to display on the widget.

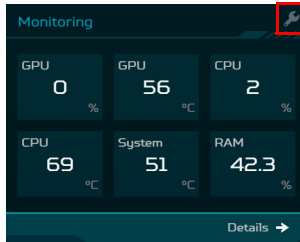

- Under the **Live Update** tab, you have the option to manually check for available updates any time by clicking on the **Check Now** button. For more detailed view of available updates, simply select **Details** to access the **Update List**.

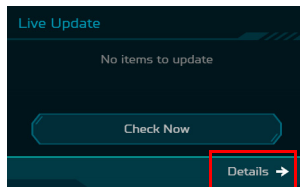

- Under the **App Shortcut** tab, click on an app will promptly open it. For an expanded array of available apps, select **Details** to access the **App Center**.

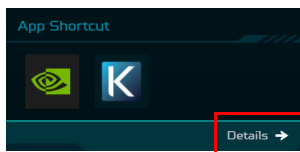

PredatorSense settings

Click the *Settings* icon , and the interface presents to you the current version of *PredatorSense*. You are able to update the firmware manually, set automatic checks for the system updates, change temperature units, and activate 3D avatar on the main screen.

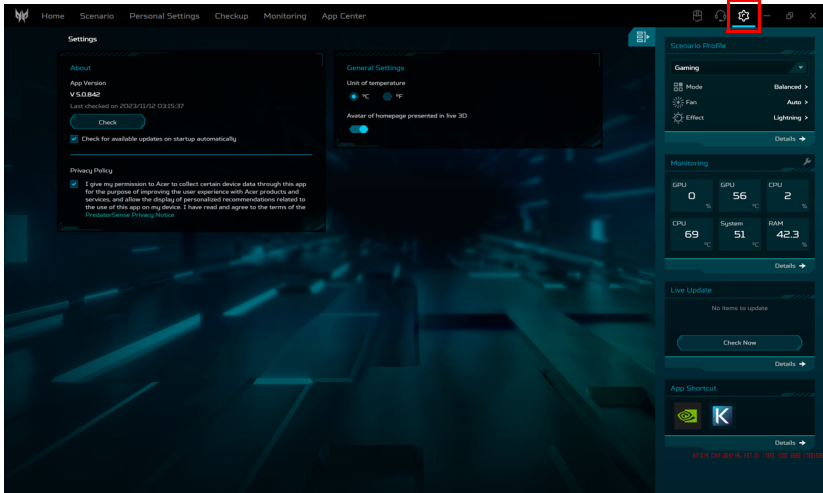

Account and Support

Click the *Support* icon  to enter the **Account & Support** screen. It displays the laptop's model number, Serial Number (SN), and Serial Number Identification Number (SNID) which are related to product specifications and warranty. You can either sign in or sign up for an Acer ID and register your Acer product. As a valued Acer user or Acer member, you can access a comprehensive range of benefits and services. Within this screen, **Find an Answer** provides you full support in resolving common issues through knowledge base searches or discussions with other Acer product owners and enthusiasts. If you can't find an answer to your question, please refer to the **Contact Us** to locate your local service center for further assistance.

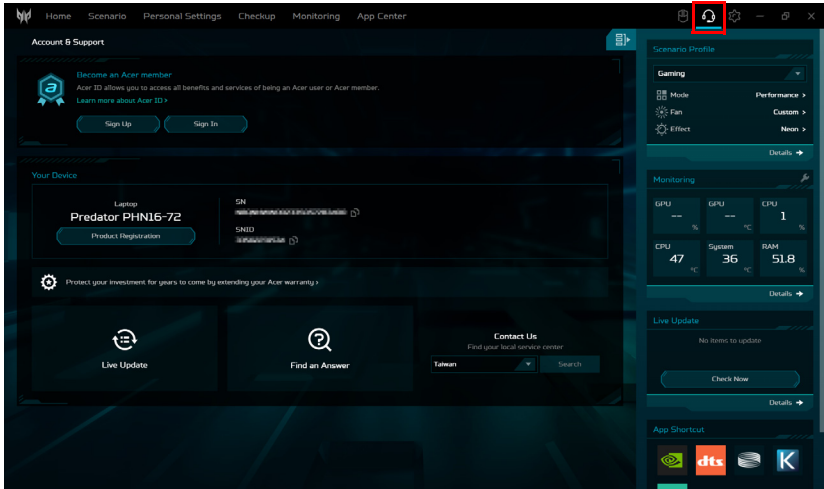

Planet9 website and PC client download

Click the *Planet9* icon  to view gaming updates. Click **PLANET9** to access the Planet9 website or click **Download PLANET9 PC Client** to download the Planet9 app to your laptop.

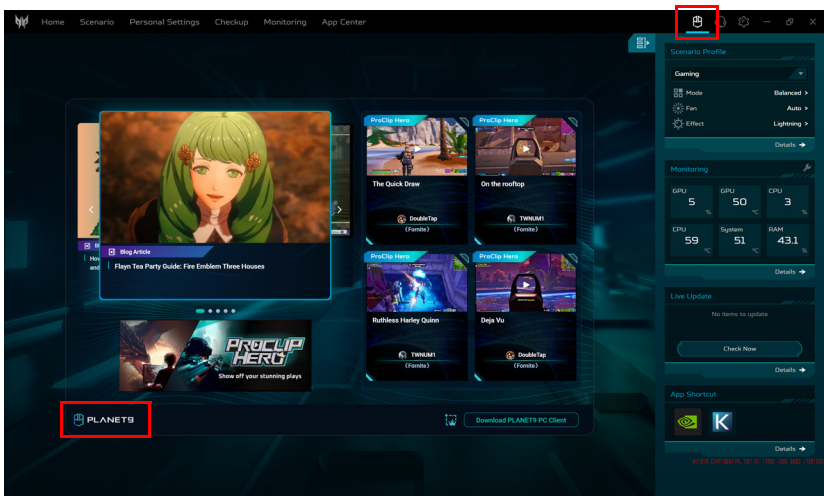

Scenario

Select the **Scenario** tab to manage scenarios by different **Mode**, **Fan Control**, **Pulsar Lighting**, and **Advanced Settings**.

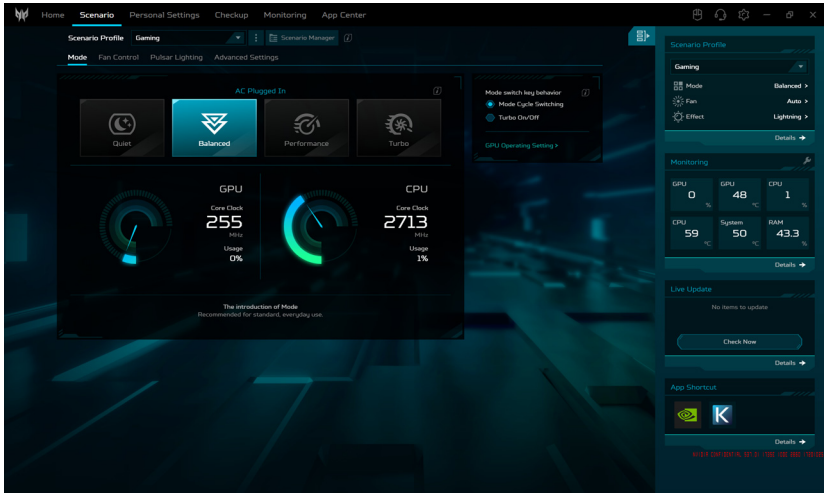

Scenario Profiles

You can create, rename, duplicate, restore or remove a scenario profile. Each profile can be redefined in **Scenario Manager**.

To manage the scenario profiles, click **Scenario Manager**.

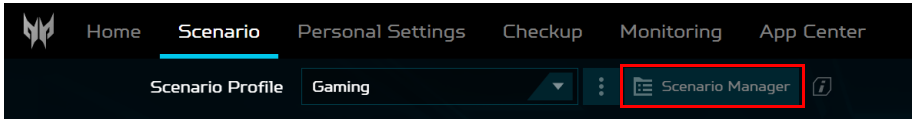

Creating a New Scenario Profile

You can create scenario profiles with customized system mode, fan performance, lighting effect, Acer TrueHarmony™ setting, and linked apps.

To add a new profile, do the following:

1. Click  in **Scenario** screen > **Add New** (from the drop-down list). Enter a new name for the profile and click **Create**.

Or

2. Select **Scenario Manager** > **New Scenario Profile**. Enter a new name for the profile and click **Create**.

Then, you can configure the scenario options for the new ones.

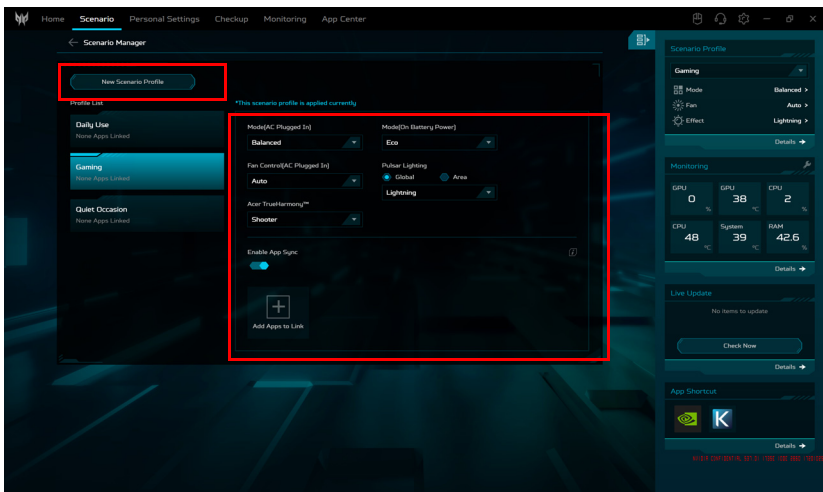

Note

Linked app means that when you run the app, it will automatically switch to the associated scenario profile. You can link apps both in the Scenario Manager and in the App Center.

App Sync settings

Turn on the App Sync function if you have more than one scenario. Click the *Add Apps to Link* icon.

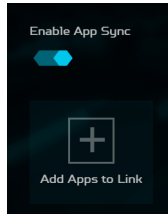

Select the apps that you want to add and click **Save**.

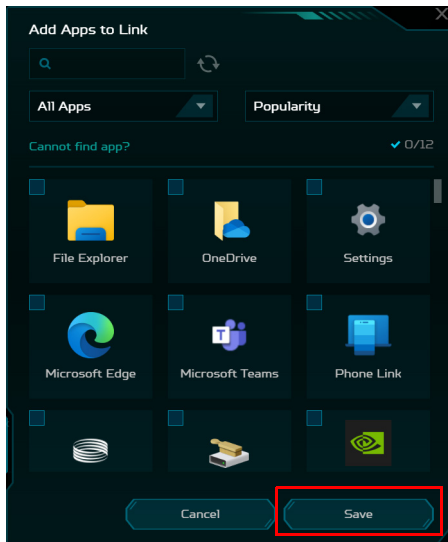

To remove the app, click the *Delete* icon  next to the app.

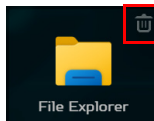



Note

You can also link/unlink apps under the **App Center** tab. Hover the cursor over the app that you want to link and click the Adjust icon

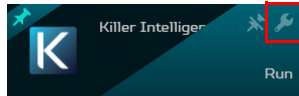

Select the scenario profile from the System Scenario Profile drop-down list and click **Save**.

To unlink, select the Unlink Scenario from the System Scenario Profile drop-down list and click **Save**.

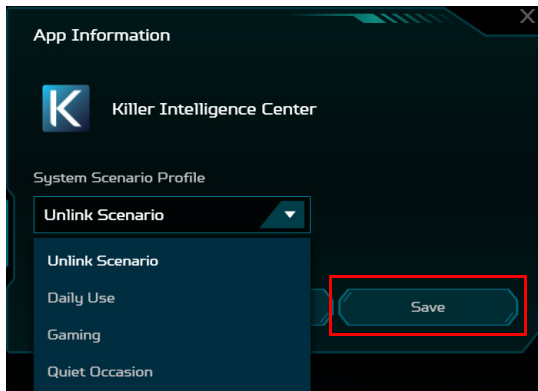

System Mode

You can optimize your laptop with different modes using the widget card or select the **Mode** tab under **Scenario** screen.

There are two or four distinct preset modes (depends on your power supply) of selection. Choose the one that best suits for your specific use case.

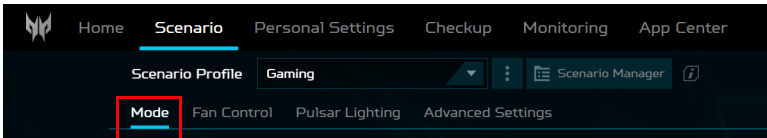

According to the power supply of your laptop, **AC Plugged In** or **On Battery Power**, you can choose from **Quiet**, **Balanced**, **Performance**, **Turbo** and **Eco** modes. And each of them has something specific to fulfill different usages. Lighting will show the color effect for a short period of time when changing modes.

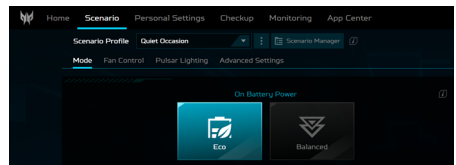
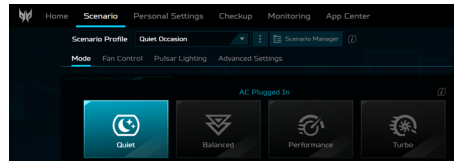
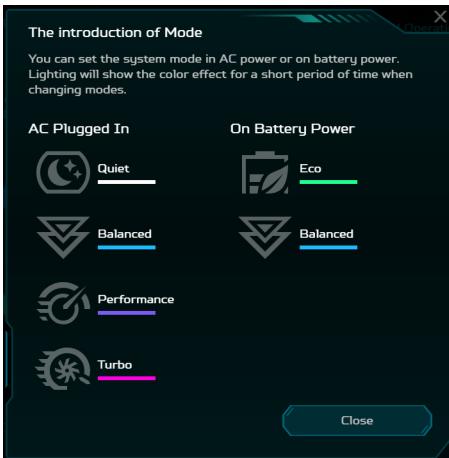

- Select the preferred option under Mode switch key, either **Mode Cycle Switching** or **Turbo On/Off**, to change the system mode of the current scenario quickly.

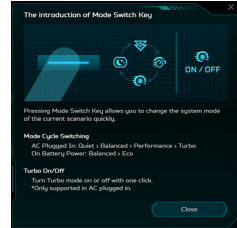
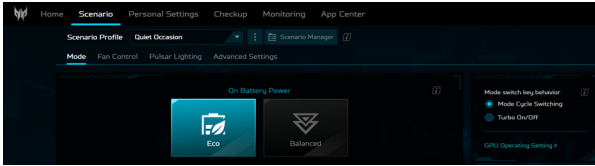

Important

While the AC is plugged in, mode switching is available when the battery capacity is at least 40%.

Fan Control

You may adjust the performance of the fans cooling your laptop's CPU and GPU. Three levels are available: **Auto** (default), **Max** and **Custom**.

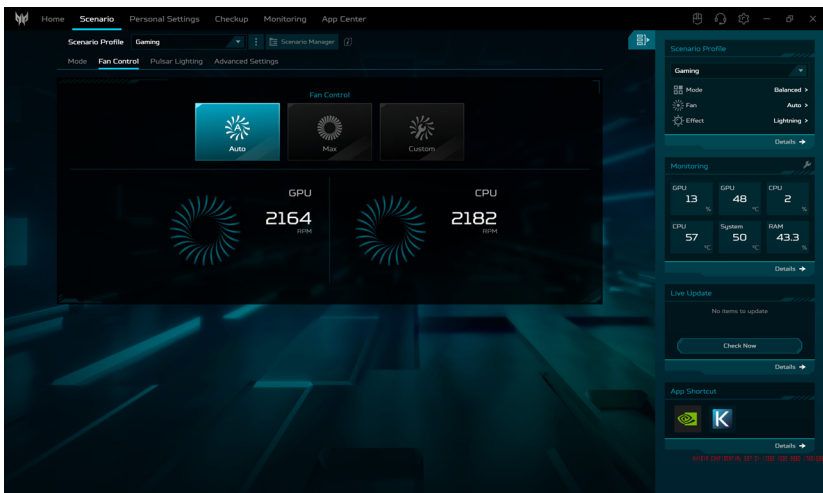

If **Custom** is selected, you have the option to set GPU and CPU cooling independently. Click **Auto** to disable the default setting and then drag the slider to adjust the value as you wish.



Pulsar Lighting

Customizing your favored lighting effect under keycaps either globally or in certain area is accessible.

You can also set up **Backlight off after 30 seconds** option, see page 65.

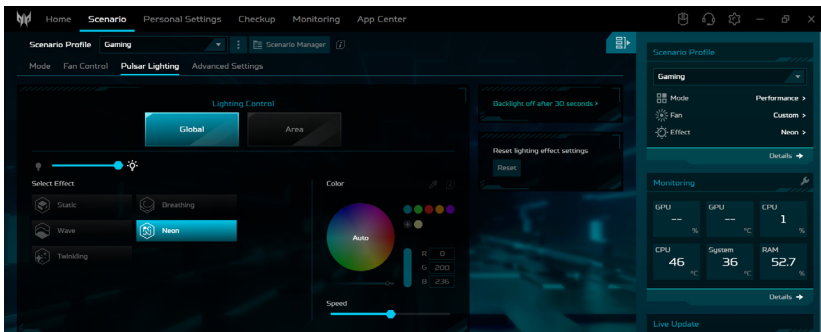

Note

Lighting effects are controlled by **Windows Dynamic Lighting** by default. You have the option to disable the default setting and discover the predesigned lighting effects to experience specific lighting styles by PredatorSense.

Global lighting

Select **Global** to customize the lighting effect for the keyboard. Depending on the effect, you may customize its color, speed, and direction.

Area lighting

Select **Area** > **To Area Control** to customize the lighting effect for the keyboard by adjusting each LED zone individually.

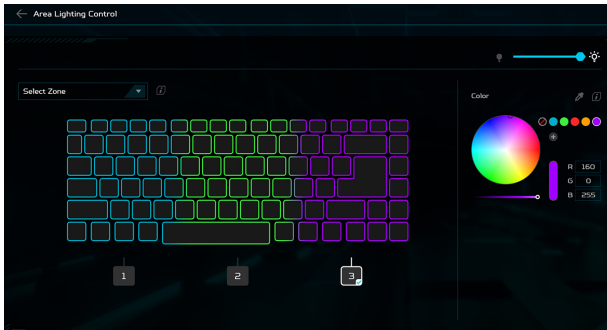
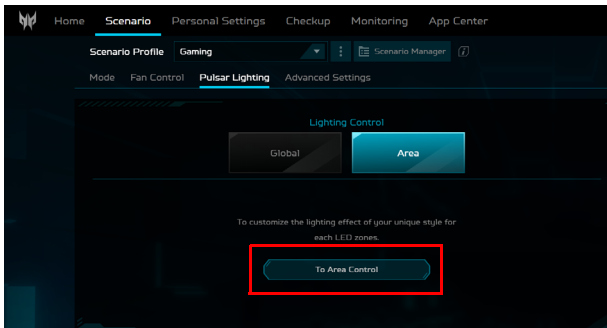

If you don't like the newly set effect, you can always reset to the original settings. Click **Reset** to restore to default.

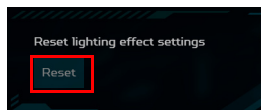

Keyboard-Static lighting

The backlight colors of individual keys may be changed: select one or more keys (hold **Ctrl** and click or drag to select multiple keys), or select a set of keys (such as the Number rows or Arrow keys) from the *Select Zone* drop-down list.

Select a color from the color wheel or enter RGB values manually. You can also adjust the color intensity and the keyboard backlight brightness.

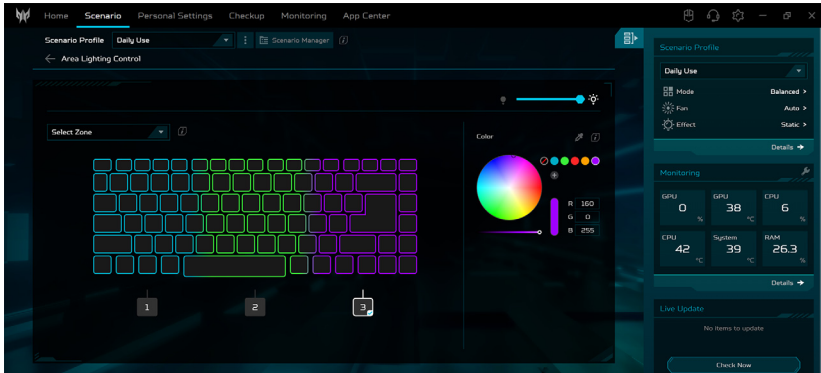

Keyboard-Dynamic lighting

Select **Dynamic** to see a set of animated light effects. Each effect provides animation for the backlight colors.

Depending on the effect, you may customize its color, speed, intensity and direction. You can also adjust the keyboard backlight brightness.

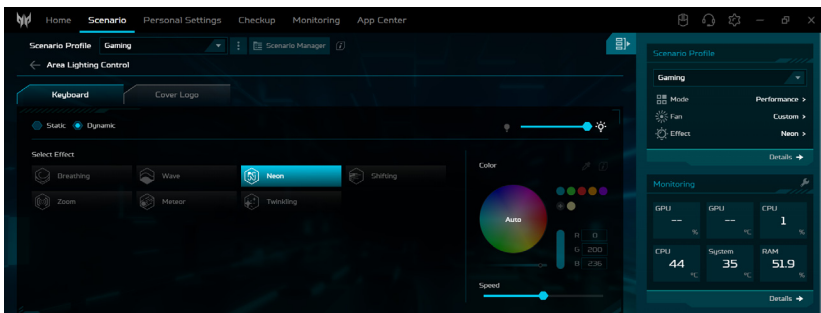

Cover Logo lighting

The lighting effect of the Cover Logo may be changed. You have the option to select from **Static**, **Breathing** and **Neon**. Depending on the effect, you may customize its color, intensity, brightness and speed.

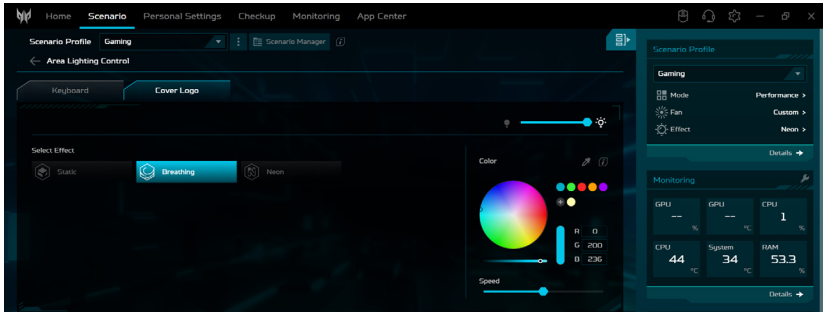

Adjusting the Advanced Settings

Select **Advanced Settings** tab to adjust the audio mode under the **Acer TrueHarmony™** tab.

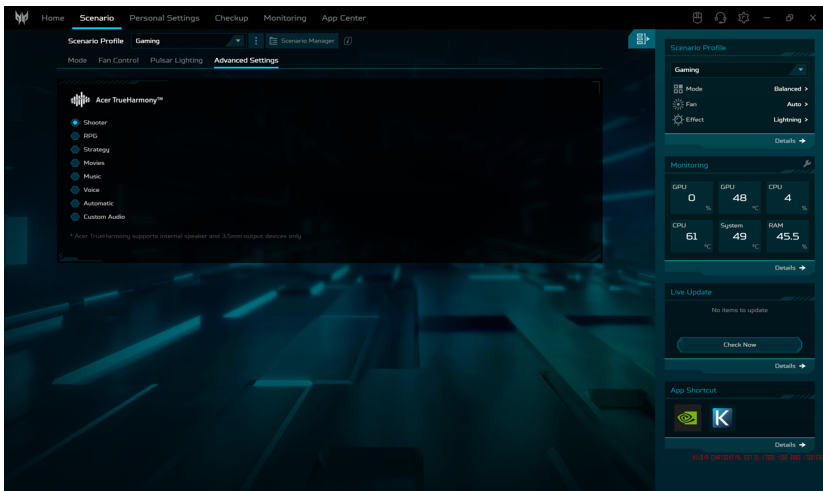

Personal Settings

In the **Personal Settings** screen, you can configure the GPU operating mode, battery charging mode, screen, keyboard and system boot effect according to your preferences.

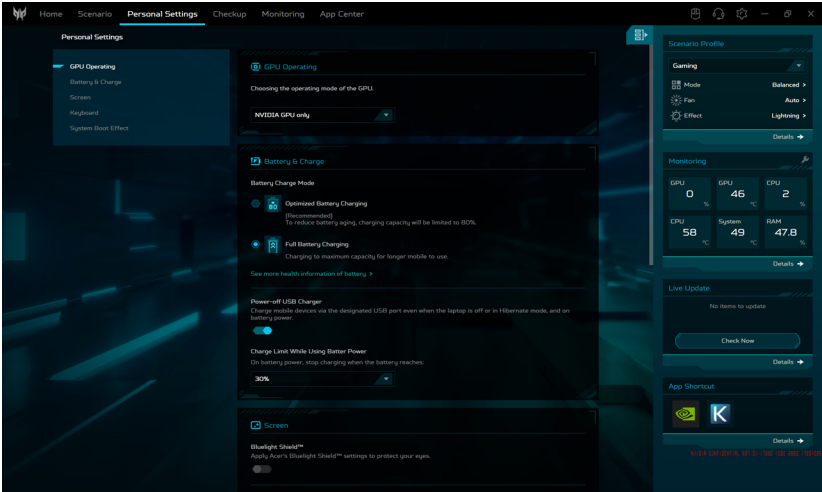

GPU Operating

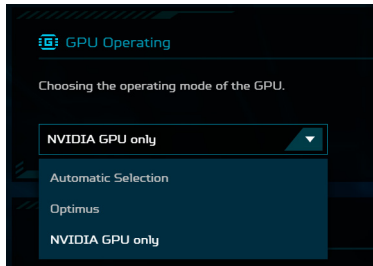

There are three available modes to choose from: **Automatic Select**, **Optimus** and **NVIDIA GPU only**. Choose the one that best fits your situation.

Battery and Charge



- **Battery Charge Mode**

There are two battery charging options available for your selection: **Optimized Battery Charging** and **Full Battery Charging**. It is highly recommended to opt for the **Optimized Battery Charging** mode. When this mode is selected, the system charges the battery up to 80% capacity, effectively enhancing the overall battery life.

- **Power-off USB Charger**

Make use of the designated USB port to charge mobile devices, even when the laptop is powered off or in Hibernation mode. In addition, you can set a battery level; when the battery power drops below this set level, the charging will be automatically halted. This feature serves to optimize laptop energy, particularly in situation where a power adapter is not available.

Screen

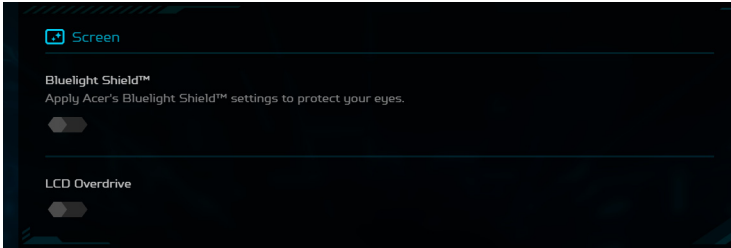

- **Bluelight Shield™**

The Bluelight Shield™ can be enabled to reduce blue-light emissions from the screen to protect your eyes. You have the flexibility to toggle Bluelight Shield™ on or off, and choose from four different modes (**Low Reduction**, **Medium Reduction**, **High Reduction** and **Long Hour Mode**) to fit your needs.



- **Low Reduction:** Reduces blue light emission from the LED backlit screen by 10% to 25% for basic protection.
- **Medium Reduction:** Reduces blue light emission from the LED backlit screen by 26% to 45% to protect your eyes.
- **High Reduction:** Reduces blue light emission from the LED backlit screen by 46% to 65% for maximum protection.
- **Long Hour Mode:** Professionally tuned to reduce eye strain over an extended period of time.

- LCD Overdrive

LCD Overdrive is a technology that helps to reduce the response time of LCD displays, which can lead to less motion blur and smoother image transitions. You can set LCD Overdrive which boosts the screen response times to 3 millisecond, resulting in faster pixel transitions and less motion blur. This can be especially beneficial for gaming and fast-paced video contents.

Keyboard

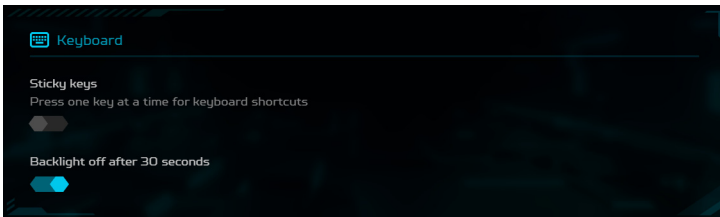

- Sticky keys

Sticky keys is a Windows accessibility feature that allows a modifier key, like the Shift key, to remain active after it is pressed. This allows you to type keyboard shortcuts one key at a time, rather than pressing them all at the same time.

- Backlight off after 30 seconds

The keyboard backlight on Acer Predator gaming laptops will turn off automatically after 30 seconds when there is no action taken. You can disable the backlight timeout if you want the backlight to stay on all of the time.

System Boot Effect

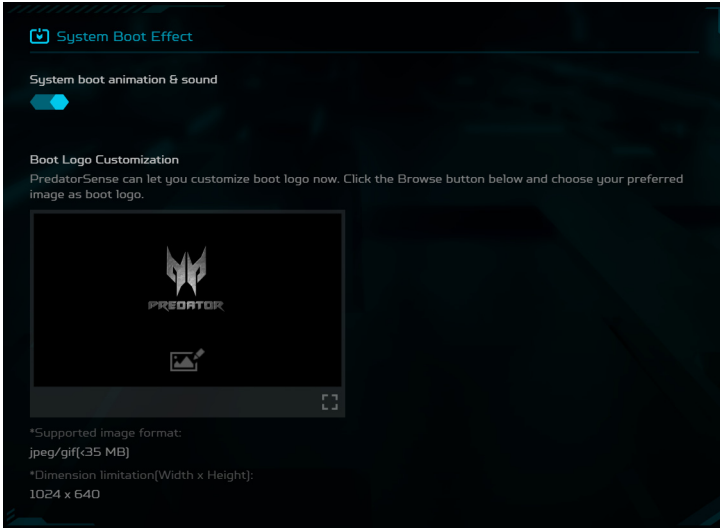

- **Boot Logo Customization**
Under the **Boot Logo Customization** tab, click the *Image* icon then browse to select your preferred image to customize the boot logo.

Checkup

Select the **Checkup** tab to swiftly evaluate the health of your system components including battery, storages and RAM with just one single click - **Checkup All**. You can also check the individual health by clicking **Check** under each variable.

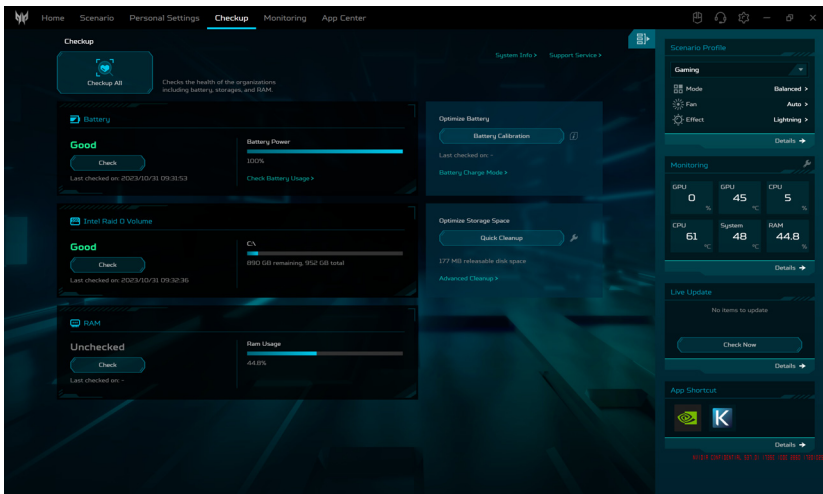

- **Battery**

For a comprehensive view of battery usages details, click **Check Battery Usage**. In addition, the **Battery Power** shows an estimate of the remaining battery time, along with a percentage display. To ensure optimal battery performance, it is recommended to perform **Battery Calibration** on a regular basis.

- **Storage**

To assess the health status of your storage, initiate the evaluation by clicking the **Check** button. To optimize laptop performance, utilize either **Quick Cleanup** or **Advanced Cleanup** to efficiently remove temporary and unnecessary files, helping you clean up storage space and speed up your laptop.



Note

Click the tool icon  of **Quick Cleanup** option and select the types of content you want to delete: **Browser cache**, **Temporarily files** and **Trash bin**.

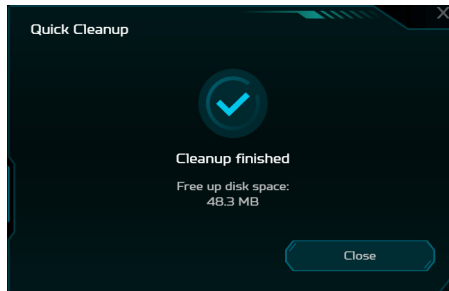
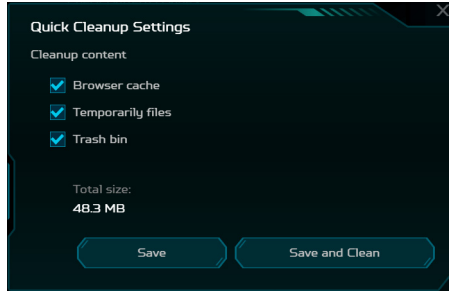

- RAM

To assess the health status of your RAM, click the **Check** button and view the current RAM usage.



Note

Specifications vary depending on model or Operating System.

Monitoring

Select the **Monitoring** tab to check CPU, GPU, and system temperature and loading. Data is shown for the last 60 minutes, so you can track your CPU, GPU and system's status after performing different tasks.

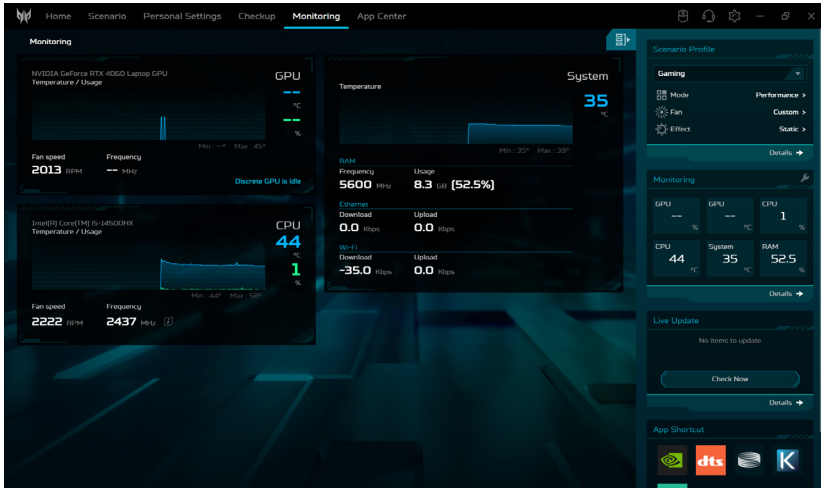

App Center

Select the **App Center** tab to swiftly launch the installed app on your laptop. In case you cannot locate the app within the comprehensive list of **All Apps**, utilize the search function. In addition, you can refine the display by showing only preloaded apps or games, and organize them based on **Popularity**, **Alphabet**, or **Installation Date**. If the app is newly installed, then click the *Refresh* icon  to reload the view.

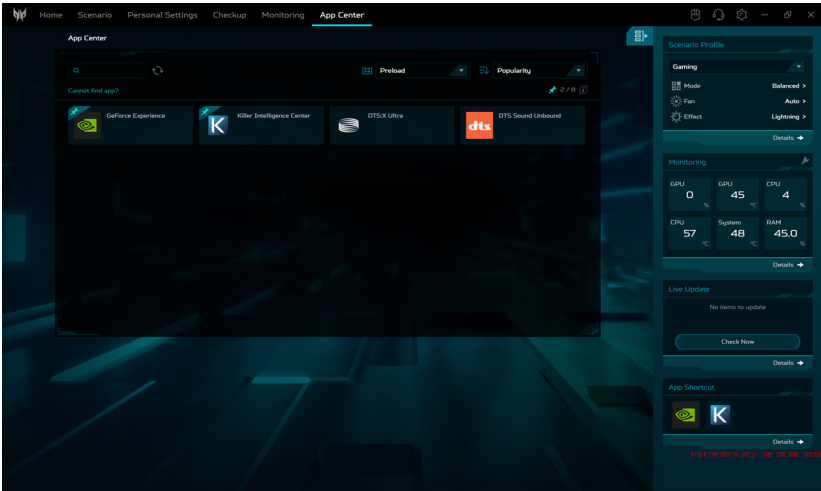

Note

For ease of access, you can pin the app shortcut to the widget card. To do so, hover the cursor over the app and click the Pin icon . To unpin the app from the widget card, repeat the step.

App Center

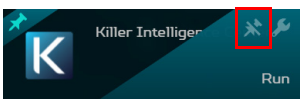

Widget card

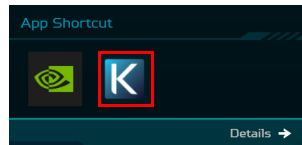

Keeping your computer and data safe...

In this section you will find:

- How to secure your computer
- Setting passwords
- What you need to prepare when you're traveling
- How to get the most out of your battery

SECURING YOUR COMPUTER

Your computer is a valuable investment that you need to take care of. Learn how to protect and take care of your computer.

Security features include hardware and software locks — a security notch and passwords.

Using a computer security lock

The computer comes with a computer security slot for a security lock.

Wrap a computer security lock cable around an immovable object such as a table or handle of a locked drawer. Insert the lock into the notch and turn the key to secure the lock. Some keyless models are also available.

Using passwords

Passwords protect your computer from unauthorized access. Setting these passwords creates several different levels of protection for your computer and data:

- Supervisor Password prevents unauthorized entry into the BIOS utility. Once set, you must enter this password to gain access to the BIOS utility. **See Setting passwords on page 74.**
- User Password secures your computer against unauthorized use. Combine the use of this password with password checkpoints on boot-up and resume from Hibernation (if available) for maximum security.
- Password on Boot secures your computer against unauthorized use. Combine the use of this password with

password checkpoints on boot-up and resume from Hibernation (if available) for maximum security.



Important

Do not forget your Supervisor Password! If you forget your password, please get in touch with your dealer or an authorized service center.

Entering passwords

When a password is set, a password prompt appears in the center of the display screen.

- When the Supervisor Password is set, a prompt appears when you enter the BIOS utility.
- Type the Supervisor Password and press **Enter** to access the BIOS utility. If you enter the password incorrectly, a warning message appears. Try again and press **Enter**.
- When the User Password is set and the password on boot parameter is enabled, a prompt appears at boot-up.
- Type the User Password and press **Enter** to use the computer. If you enter the password incorrectly, a warning message appears. Try again and press **Enter**.



Important

You have three chances to enter a password. If you fail to enter the password correctly after three tries, the system halts. Press and hold the power button for four seconds to shut down the computer. Then turn on the computer again, and try again.

BIOS UTILITY

The BIOS utility is a hardware configuration program built into your computer's BIOS.

Your computer is already properly configured and optimized, and you do not normally need to run this utility. However, if you encounter configuration problems, you may need to run it.

To activate the BIOS utility, press **F2** while the computer logo is being displayed.

Boot sequence

To set the boot sequence in the BIOS utility, activate the BIOS utility, then press **F1** to access the **Advanced Settings** to select **Boot** from the categories listed on the left of the screen.

Setting passwords

To set a password on boot, activate the BIOS utility, then press **F1** to access the **Advanced Settings** to select **Security** from the categories listed on the left of the screen.

Find **Set Supervisor Password** and enter a password to enable this feature. Once you have entered a password for this feature, you may then enable/disable **Password on Boot**.

Remember to select **F10** to properly save and exit the BIOS utility when you are done making changes.

POWER MANAGEMENT

This computer has a built-in power management unit that monitors system activity. System activity refers to any activity involving one or more of the following devices: keyboard, mouse, hard disk, peripherals connected to the computer, and video memory. If no activity is detected for a period of time, the computer stops some or all of these devices in order to conserve energy.

Saving power

Disable Fast startup

Your computer uses Fast startup to start quickly, but also uses a small amount of power to check for signals to start. These checks will slowly drain your computer's battery.

If you prefer to reduce your computer's power requirements and environmental impact, turn off Fast startup:



Note

If Fast startup is off, your computer will take longer to start from Sleep.

Your computer will also not start if it receives an instruction to start over a network (Wake on LAN).

1. Press the *Windows key* or select the *Windows Start button* then search for "**Choose a power plan**".
2. Select **Choose what the power buttons do**.

3. Select **Change settings that are currently unavailable**.

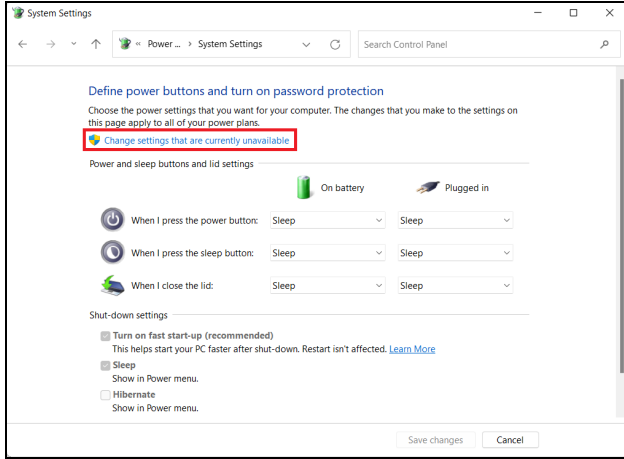

4. Scroll down and disable **Turn on fast start-up**.

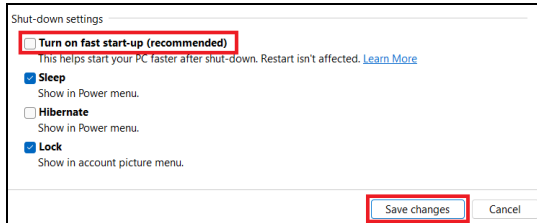

5. Select **Save changes**.

BATTERY PACK

The computer uses an embedded Lithium battery that gives you long use between charges.

Battery characteristics

The battery is recharged whenever you connect the computer to the AC adapter. Your computer supports charge-in-use, enabling you to recharge the battery while you continue to operate the computer. However, recharging with the computer turned off significantly reduces charge time.

The battery will come in handy when you travel or during a power failure.

Charging the battery

Plug the AC adapter into the computer, and connect to a mains power outlet.



Note

You are advised to charge the battery before retiring for the day. Charging the battery overnight before traveling enables you to start the next day with a fully charged battery.

Conditioning a new battery pack

Before you use a battery pack for the first time, there is a conditioning process that you should follow:

1. Connect the AC adapter and fully charge the battery.
2. Turn on the computer and complete setting up the operating system.
3. Disconnect the AC adapter.
4. Operate the computer using battery power.
5. Fully deplete the battery until the battery-low warning appears.

6. Reconnect the AC adapter and fully charge the battery again.

Follow these steps again until the battery has been charged and discharged three times.

Use this conditioning process for all new batteries, or if a battery hasn't been used for a long time.



Warning

Do not expose battery packs to temperatures below 0° C (32° F) or above 45° C (113° F). Extreme temperatures may adversely affect the battery pack.

The battery conditioning process ensures your battery accepts the maximum possible charge. Failure to follow this procedure will prevent you from obtaining the maximum battery charge, and will also shorten the effective lifespan of the battery.

In addition, the useful lifespan of the battery is adversely affected by the following usage patterns:

- Using the computer on constant AC power.
- Not discharging and recharging the battery to its extremes, as described above.
- Frequent use; the more you use the battery, the faster it will reach the end of its effective life. An embedded battery has a life span of more than 1,000 charge/discharge cycles.

Optimizing battery life

Optimizing battery life helps you get the most out of battery operation, prolonging the charge/recharge cycle and improving recharging efficiency. You are advised to follow the suggestions set out below:

- Use AC power whenever possible, reserving battery for mobile use.
- Remove accessories that are not being used (e.g. a USB disk drive), as they can continue to draw power.

- Store your PC in a cool, dry place. The recommended temperature is 10° C (50° F) to 30° C (86° F). Higher temperatures cause the battery to self-discharge faster.
- Excessive recharging decreases the battery life.
- Look after your AC adapter and battery.

Checking the battery level

The power meter indicates the current battery level. Rest the cursor over the battery/power icon on the taskbar to see the battery's present charge level.

Battery-low warning

When using battery power pay attention to the power meter.



Important

Connect the AC adapter as soon as possible after the battery-low warning appears. Data may be lost if the battery is allowed to become fully depleted and the computer shuts down.

When the battery-low warning appears, the recommended course of action depends on your situation:

Situation	Recommended Action
The AC adapter and a power outlet are available.	<ol style="list-style-type: none"> 1. Plug the AC adapter into the computer, and then connect to the main power supply. 2. Save all necessary files. 3. Resume work. <p>Turn off the computer if you want to recharge the battery rapidly.</p>
The AC adapter or a power outlet is unavailable.	<ol style="list-style-type: none"> 1. Save all necessary files. 2. Close all applications. 3. Turn off the computer.

TRAVELING WITH YOUR COMPUTER

This section gives you tips and hints to consider when moving around or traveling with your computer.

Disconnecting from the desktop

Follow these steps to disconnect your computer from external accessories:

1. Save any open files.
2. Shut down the computer or put it into Sleep or Hibernate mode.
3. Close the display cover.
4. Disconnect the cord from the AC adapter.
5. Disconnect the keyboard, pointing device, printer, external monitor and other external devices.
6. Disconnect the Kensington / Noble lock if you are using one to secure the computer.

Moving around and what to bring with you

When you are just moving within short distances, you probably do not need to bring anything with you other than your computer. If your battery is not fully charged, you may want to bring the AC adapter with you to plug in your computer. If you cannot find an electrical outlet, reduce the drain on the battery by putting the computer in Sleep mode. Press the Sleep hotkey or close the display cover whenever you are not actively using the computer.

When you are moving within a larger distance, for instance, traveling locally or internationally, after shutting down the computer and disconnecting any external devices, pack the computer in a protective case that can prevent the computer

from sliding around and cushion it if it should fall.



Note

The computer may enter Hibernation or Deep Sleep mode after being in Sleep mode for a period of time.

Ports and connectors...

In this section you will find:

- Information on the ports and connectors fitted to your computer

UNIVERSAL SERIAL BUS (USB)

The USB port is a high-speed port which allows you to connect USB peripherals, such as a mouse, an external keyboard, additional storage (external hard disks), or any other compatible device.

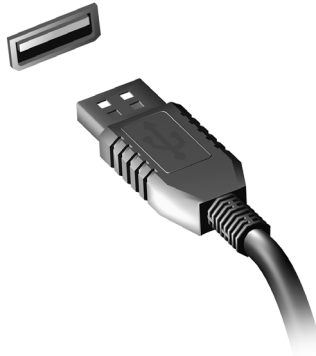

Note

Two USB standards are currently available on Predator computers: USB 2.0 (High-speed USB) and USB 3.2 Gen 2 (SuperSpeed USB). USB 2.0 ports on Predator computers have a black tongue in the port, while USB 3.2 Gen 2 ports have a blue tongue. For best performance, USB 3.2 Gen 2 devices should always be plugged into USB 3.2 Gen 2 ports. Consult your device's documentation to see which standard it supports.

You can also charge devices such as tablets, smartphones, or other devices through a USB port. Some USB 3.2 Gen 2 ports support charging devices when the computer is in Hibernate or turned off. Additionally, you can use a USB hub to connect multiple devices to a single USB port.



Important

When removing a USB storage device, you should right-click on the USB icon in the Windows task bar and select "Eject <device>" to tell the operating system to stop using the device before removing it. Failure to do this may result in data loss or damage to your peripheral.

USB TYPE-C PORT

A USB Type-C port is a connector that allows you to easily connect USB Type-C peripherals, such as additional storage (e.g. an external drive), or any other compatible device.

The Type-C port is reversible; connectors may be inserted with either side up.

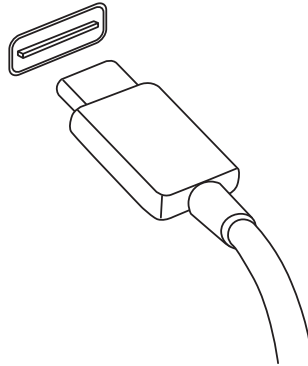

Note

On Predator computers USB Type-C ports support up to USB 3.2. Other USB devices with a USB Type-C connector are supported, but transfer speed may be reduced and certain functions will be disabled (such as Thunderbolt video support).



Important

When removing a USB storage device, you should right-click on the USB icon in the Windows task bar and select "Eject <device>" to tell the operating system to stop using the device before removing it. Failure to do this may result in data loss or damage to your peripheral.

THUNDERBOLT 4 PORT

A Thunderbolt 4 port allows you to easily connect devices with a Type-C connector to your computer, such as additional storage (e.g. an external drive), displays, or any other compatible device. Up to six devices, including displays, can be connected in series to a single Thunderbolt port.

The Thunderbolt connection uses a USB Type-C port and is compatible with Thunderbolt, USB, DisplayPort and power on USB-C devices. The Type-C port is reversible; connectors may be inserted with either side up.

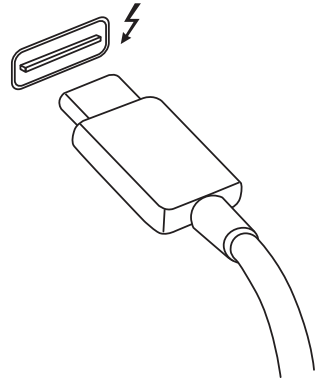

Displays

Up to two 4K displays or one 8K display with can be connected to a single Thunderbolt 4 port. If an adapter is used, DisplayPort or compatible devices, including HDMI, DVI or VGA, can be used.



Note

Thunderbolt 4 ports support transfer speeds up to 40 Gbps, and USB devices with a Type-C connector at lower speeds (typically up to 10 Gbps).

Other USB or older Thunderbolt devices with a USB Type-C connector (or adapter) are supported, but transfer speeds may be reduced and certain functions may be disabled (such as Thunderbolt display support).



Important

When removing a USB storage device, you should right-click on the USB icon in the Windows task bar and select "Eject <device>" to tell the operating system to stop using the device before removing it. Failure to do this may result in data loss or damage to your peripheral.

MICROSD CARD READER

MicroSD (Secure Digital) cards are used in a wide selection of digital cameras, tablets, media players and cellular phones.



Inserting an microSD card

1. Align the card so that the connector points towards the port, with the connectors facing down.
2. Carefully slide the card into the port. If you find you need to use any force to insert the card, try reorientating the card slightly.
3. Push the card until it clicks into place. A few millimetres of the card will extend from beyond the slot.

If the card contains some files, the *Windows AutoPlay* window may appear (this depends on the contents of the card) and ask you if you wish to use a program to access the contents of the card.



Important

When removing an microSD card, you should right-click on the USB icon in the Windows task bar and select "Eject <card name>" to tell the operating system to stop using the device before removing it. Failure to do this may result in data loss or damage to your peripheral.

SD, SDHC and SDXC cards

Different types of SD cards cover different capacities, while using the same overall design. SD cards contain up to 4 GB; SDHC cards contain up to 32 GB; and SDXC cards can contain up to 2048 GB (2 TB). Your computer provides an SDHC or SDXC compatible card reader.



Note

SDXC memory cards can only be used in an SDXC-compatible reader; SD and SDHC cards can be used in either type.

VIDEO AND AUDIO CONNECTORS

Add an external monitor to your computer via a video port. The type of port available depends on your computer's configuration.

Connecting a monitor

1. Check that the computer is powered off and the monitor power switch is turned off.
2. Attach the video cable to the monitor port on the computer.
3. Connect the monitor power cable and plug it into a properly grounded wall outlet.
4. Follow any setup instructions in the monitor's user's guide.
5. Turn on power to the monitor, then the computer.
6. The correct resolution and refresh rate should be detected automatically. If necessary, change the display settings used by the computer.



Note

*To access the display controls, right-click anywhere on the desktop and select **Display settings**.*

Headphones and microphone

One or more 3.5 mm jacks on your computer allow you to connect audio devices.

Use the headphone port to plug in stereo headphones or powered speakers; connecting an audio device to the headphone port disables the built-in speakers.

Use the microphone port to connect an external microphone; connecting a microphone disables the built-in microphone.



Note

Some computers have a single "combo" port that allows you to use single-pin headsets with a built-in microphone. These headsets are most commonly used with smartphones.

HDMI

HDMI (High-Definition Multimedia Interface) is a high-quality, digital audio/video interface. HDMI allows you to connect any compatible digital audio/video source, such as your computer, a set-top box, DVD player, and audio/video receiver to any compatible digital audio and/or video monitor, such as a digital television (DTV) with a single cable. The single cable keeps everything neat and tidy while ensuring easy connection and the best audio and visual quality.

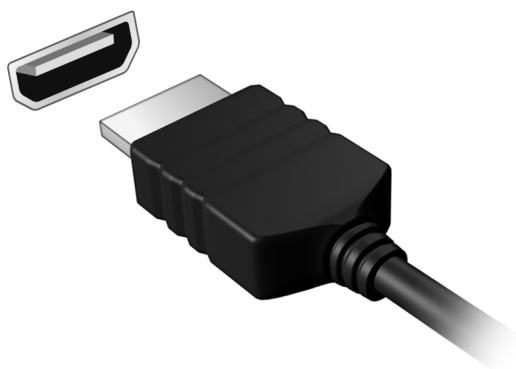

Got a question?

In this section you will find:

- Frequently asked questions
- Tips for using Windows
- Troubleshooting information
- How to protect yourself while online
- Where to find Acer service center contact information

FREQUENTLY ASKED QUESTIONS

The following is a list of possible situations that may arise during the use of your computer. Easy solutions are provided for each one.

I turned on the power, but the computer does not start or boot up.

Check if power is being supplied to the computer (if your computer has a power indicator, it will be off); if there is no power, check the following:

- If you are using on the battery, it may be low and unable to power the computer. Connect the AC adapter to recharge the battery pack. You may need to wait a few minutes before trying to turn your computer on again.
- Make sure that the AC adapter is properly plugged into the computer and to the power outlet.

If power is being supplied to the computer, check the following:

- Do you have a USB storage device (USB drive, CD drive or smartpone) plugged into your computer? Unplug it and press **Ctrl + Alt + Del** to restart the system.

Nothing appears on the screen.

The computer's power management system automatically blanks the screen to save power. Press any key to turn the display back on.

If pressing a key does not turn the display back on, three things might be the cause:

- The brightness level might be too low. Use the *Brightness up* hotkey to adjust the brightness level.
- The display device might be set to an external monitor. Press the display toggle hotkey to toggle the display back to the computer.

- The computer may be in Sleep or Hibernate mode (if there is a power LED, it will flash). Press and release the power button to resume.

No audio is heard from the computer.

Check the following:

- The volume may be muted. Look at the volume control (speaker) icon in the taskbar. If it is crossed-out, click the icon and drag the slider to the right to increase the volume.
- The volume level may be too low. Check the volume from the volume control (speaker) icon in the taskbar. You can also use the volume control hotkeys to adjust the volume.
- If headphones, earphones or external speakers are connected to the headphone jack on the computer, the internal speakers automatically turn off.

The keyboard does not respond.

Try attaching an external keyboard to a USB port on the computer. If it works, contact your dealer or an authorized service center as the internal keyboard cable may be loose.

The printer does not work.

- Make sure that the printer is connected to a power outlet and that it is turned on.
- Make sure that the printer cable is connected securely to a USB port and the corresponding port on the printer.

I want to restore my computer to its original settings.



Note

If your system is the multilingual version, the operating system and language you choose when you first turn on the system will be the only option for future recovery operations.

This recovery process helps you restore the C: drive with the original software content that is installed when you purchased your computer.

**Warning**

Your C: drive will be reformatted and all data will be erased. It is important to back up all data files before using this option.

Before performing a restore operation, please check the BIOS settings.

1. If there is a **D2D Recovery** setting in **Main**, make sure it is **Enabled**.
2. Exit the BIOS utility and save changes. The system will reboot.

**Note**

*To access the BIOS utility, press **F2** when you see the Predator logo during boot up.*

For more information, see **Restoring your computer on page 33**.

Requesting service

International Travelers Warranty (ITW)

Your computer is backed by an International Travelers Warranty (ITW) that gives you security and peace of mind when traveling. An ITW passport came with your computer and contains all you need to know about the ITW program. A list of available, authorized service centers is in this handy booklet. Read this passport thoroughly.

Always have your ITW passport on hand, especially when you travel, to receive the benefits from our support centers. Attach your proof-of-purchase to the ITW passport.

If the country you are traveling in does not have an Acer-authorized ITW service site, you can still get in contact with our offices worldwide. Please visit **www.acer.com**.

Before you call

Please have the following information available when you call Acer for online service, and please be at your computer when you call. With your support, we can reduce the amount of time a call takes and help solve your problems efficiently. If there are error messages or beeps reported by your computer, write them down as they appear on the screen (or the number and sequence in the case of beeps).

You are required to provide the following information:

Name:

Address:

Telephone number:

Machine and model type:

Serial number:

Date of purchase:

Tips and hints for using Windows

We know this is a new operating system that will take some getting used to, so we've created a few pointers to help you get started.

Can I turn off notifications?

You can turn off notifications so that you can leave your computer running, but not be disturbed by notifications.

Press the *Windows key* or select the *Windows Start button* and select **Settings** > **System** > **Notifications**. From here you can enable/disable notifications for all of your apps or choose which apps to enable/disable.

Can I personalize the Lock screen?

You can personalize the lock screen with a different image, to run a slideshow of images, or to show you quick status and notifications to suit your personal needs.

To change the background, press the *Windows key* or select the *Windows Start button* and select **Settings** > **Personalization** > **Lock screen**. From here you can:

- Select a background image for the lock screen
- Turn the *Slideshow* on or off
- Select lock screen apps.

How do I set up the lock screen slideshow?

1. Press the *Windows key* or select the *Windows Start button* and select **Settings** > **Personalization**.
2. Under Lock screen, select *Slideshow*.
3. Click **Browse** and open the folder you wish to use (your *Pictures* folder will open by default). Select **Choose this folder** to add the folder to the lock screen slideshow.
4. Select a folder and select **Remove** to remove the folder from the lock screen slideshow.
5. Change the other settings to suit your needs.

Can I change the screen resolution?

Type 'Resolution' in the text box to display the results; select **Display resolution**. Alternatively, you can also right-click anywhere on the desktop and select **Display settings > Display > Display resolution**.

Where are my apps?

Move your cursor to the lower side of the screen and click search box, start typing the name of the app you would like to open.

How do I make an app appear on Start?

If you're in all apps list and you want to make an app appear on *Start*, right-click an app and select **Pin to Start**.

How do I remove a tile from Start?

Right-click a tile to select it and select **Unpin from Start** to remove the tile from *Start*.

How do I make an app appear on my taskbar?

If you're in all apps list and you want to make an app appear on the taskbar, right-click an app and select **More > Pin to taskbar**.

How do I install apps?

You will need to have a Microsoft ID to purchase and download apps from *Microsoft Store*.

What is a Microsoft ID (account)?

A Microsoft account is an email address and password that you use to sign in to Windows. You can use any email address, but it is best if you choose the one you already use to communicate with friends and sign in to your favorite websites. When you sign in to your PC with a Microsoft account, you'll connect your PC to the people, files, and devices you care about.

Do I need one?

You need a Microsoft ID to use Windows 11. It makes life easier because you can sync data across different machines you sign in to using a Microsoft ID.

How do I check for Windows updates?

Press the *Windows key* or select the *Windows Start button* > **Settings** > **Windows Update**. Select **Advanced options** to configure the settings.

Where can I get more information?

For more information please visit the following pages:

- Windows OS information: support.microsoft.com/Windows
- Support FAQs: support.acer.com

Troubleshooting

This chapter shows you how to deal with common system problems.

Read it before calling a technician if a problem occurs. Solutions to more serious problems require opening up the computer. Do not attempt to open the computer yourself; contact your dealer or authorized service center for assistance.

Troubleshooting tips

This computer incorporates an advanced design that delivers onscreen error message reports to help you solve problems.

If the system reports an error message or an error symptom occurs, see "Error messages" below. If the problem cannot be resolved, contact your dealer.

Error messages

If you receive an error message, note the message and take the corrective action. The following table lists the error messages in alphabetical order together with the recommended course of action.

Error messages	Corrective action
CMOS battery bad	Contact your dealer or an authorized service center.
CMOS checksum error	Contact your dealer or an authorized service center.
Disk boot failure	Insert a system (bootable) disk, then press Enter to reboot.
Equipment configuration error	Press F2 (during POST) to enter the BIOS utility, then press Exit in the BIOS utility to reboot.
Hard disk 0 error	Contact your dealer or an authorized service center.

Error messages	Corrective action
Hard disk 0 extended type error	Contact your dealer or an authorized service center.
I/O parity error	Contact your dealer or an authorized service center.
Keyboard error or no keyboard connected	Contact your dealer or an authorized service center.
Keyboard interface error	Contact your dealer or an authorized service center.
Memory size mismatch	Press F2 (during POST) to enter the BIOS utility, then press Exit in the BIOS utility to reboot.

If you still encounter problems after going through the corrective measures, please contact your dealer or an authorized service center for assistance.

INTERNET AND ONLINE SECURITY

First steps on the net

Protecting your computer

It is vital to protect your computer from viruses and attacks over the internet (**see Internet security software on page 104**).

A comprehensive internet security program is offered when you first start your computer. You should activate this protection as soon as possible, certainly before you connect to the internet.

Choose an Internet Service Provider



Using the internet has become a natural part of daily computing. Just a few simple steps can connect you to a vast collection of knowledge and communication tools. To accomplish these steps you should first select an *Internet Service Provider* (ISP), which supplies the connection between your computer and the internet. You should research the ISPs available in your region, not forgetting to talk to friends and family about their experiences or to check reviews and consumer reports. The ISP you select will provide instructions on how to connect to the internet (you may need additional software or a special 'box' that connects to your phone line).

Connection types

Depending on your computer model, your location and your communication needs, you have several ways to connect to the internet.

Dial-up

Some computers include a telephone dial-up ('modem') connector. This allows you to connect to the internet using your telephone line. With a dial-up connection, you cannot use the modem and the telephone simultaneously on a single phone line. This type of connection is recommended only if you have limited use of the internet as the connection speed is low and connection time is typically charged per hour.

DSL (e.g. ADSL)

DSL (Digital Subscriber Line) is an 'always-on' connection that runs over the phone line. As DSL and phone do not use the same frequencies, you can use your telephone at the same time you are connected to the internet (this requires a 'micro-filter' on each telephone socket to avoid interference). To be eligible for DSL, you must be located near an DSL-equipped phone exchange (service is sometimes unavailable in rural areas). Connection speeds vary depending on your location, but DSL generally provides very fast and reliable internet connection. As the connection is always-on, it is generally charged at fixed monthly rates.



Note

A DSL connection requires an appropriate modem. A modem is usually provided by the ISP when you register. Many of these modems include an 'router' that provides network and Wi-Fi access.

Cable

A cable connection provides fast and always-on internet service via a cable television line. This service is generally available in large cities. You can use your telephone and watch cable TV at the same time you are connected to the internet.

Cellular

A cellular connection allows you to use cellular networks (such as those used by a mobile phone) to connect to the

internet while away from home. The socket for a SIM card may be built in to your computer, or may require an external device, such as a USB modem or even an appropriately equipped mobile phone.



Note

If your computer includes a SIM card slot, you require a compatible SIM card and a contract with a cellular provider. Before using the cellular features, check with your service provider to see if any additional charges will be incurred, especially roaming charges.

Network connections

A LAN (Local Area Network) is a group of computers (for example, within an office building or home) that share a common communications line and resources. When you set up a network, you can share files, peripheral devices (such as a printer) and an internet connection. You can set up a LAN using wired technologies (such as Ethernet) or wireless technologies (such as Wi-Fi or Bluetooth).

Wireless networks

A wireless LAN or WLAN is a wireless local area network, which may link two or more computers without using wires. Setting up a wireless network is easy and allows you to share files, peripheral devices and an internet connection.

What are benefits of a wireless network?

Mobility

Wireless LAN systems allow you and other users of your home network to share access to files and devices connected to the network, for example a printer or scanner.

Also you can share an internet connection with other computers in your home.

Installation speed and simplicity

Installing a wireless LAN system can be fast and easy and eliminates the need to pull cables through walls and ceilings.

Components of a wireless LAN

To set up your Wireless network at home you need to have the following:

Access point [router]

Access points [routers] are two-way transceivers that broadcast data into the surrounding environment. Access points act as a mediator between wired and wireless network. Most routers have a built-in DSL modem that will allow you access to a high speed DSL internet connection. The ISP (Internet Service Provider) you have chosen normally supplies a modem/router with the subscription to their services. Read carefully the documentation supplied with your Access point/router for detailed setup instructions.

Wireless adapter

Most computers feature a wireless module and Wi-Fi button that turns the network connection on or off. You may also turn your wireless network on or off, or control what is shared over the network with the network management options.



Warning

Using wireless devices while flying in aircraft may be prohibited. Switch off all devices before boarding an aircraft; they may be dangerous to the operation of the aircraft, disrupt communications, and even be illegal. After take off, ask the cabin crew if you may enable Wi-Fi.

Surf the Net!

To surf the internet, you need a program called an internet browser. *Microsoft Edge* provides an easy and secure web browsing experience. As soon as you have your internet access installed and you are connected, from the Start Menu,



click the Microsoft Edge app or the icon located in the taskbar and take your internet experience to a new level!

Acer website

To get you started why not visit our website, **www.acer.com**. Acer is dedicated to provide you with on-going personalized support. Check out our *Support* section to get help tailored to your needs.

www.acer.com is your portal to a world of online activities and services: visit us regularly for the latest information and downloads!

Internet security software

To help you stay ahead of cybercriminals, Acer has partnered with McAfee to offer you security for all your devices.

Select Acer computers include protection by McAfee

McAfee is pre-installed on select Acer computers, protecting your identity and financial data from viruses, spyware, malware and other online threats. Learn more about how to stay safe online and how to stay protected after your introductory subscription ends.



Note

Specifications vary depending on model or Operating System.

Staying ahead of cybercriminals

Stay ahead of hackers and cybercriminals by understanding the tactics they use to access your private data.

Ensure your software is up to date

Cybercriminals rely heavily upon software or platform vulnerabilities, as they are the easiest way to sneak malware into a user's device unnoticed, sometimes with little action on the user's part. Immediately after a software manufacturer announces an update, hackers are ready with

malware that can breach holes in the software that would have been patched if the update was installed.

How to stay safe: Perform any and all software updates as soon as they are available.

Keep a lookout for fake or phishing emails

Beware of emails that appear to be from a friend or business colleague that you know but seem a little odd. Maybe they didn't capitalize your name or there are misspellings. The email might be from cybercriminals who are trying to fool you into sending them your credit card number, social security number, or logging into a fake bank website that looks like yours but really isn't.

How to stay safe: Use a strong antispam filter. If an email looks strange, don't click on anything and delete it immediately. Instead manually launch a browser and type in your bank's website address and log-in yourself.

Don't be fooled if someone calls your phone

A tech support scam is a form of online fraud where people call you on the phone saying they're Technical Support from a trusted company like McAfee or Microsoft and that you have a virus. The main motive behind these scams is to extort money from the victim. Cybercriminals can also install malware such as keylogging software or backdoor Trojans in order to gain access to personal information.

How to stay safe: Don't fall for phone calls that tell you your software or computer isn't working. Never give your personal information like social security or credit card numbers to someone that you don't know over the phone.

Common threats cybercriminals use

Now you know a few very common ways cybercriminals try to sneak onto your device or trick you into providing private information to them directly. Here are a few of the types of malware they like to deploy once they've got into a device and what to do if you're ever infected.

Ransomware

A form of malware that will encrypt personal data files on your computer and attached devices. Encryption converts files into another format, that can only be opened with a specific decryption key. Once the ransomware installs itself, it will display a warning message that the computer is now locked. The user is given a specific amount of money to pay as a "fine" and a timeframe in which to pay. Even if paid, the criminal might choose to not unencrypt the files anyway!

What to do if you're infected: Avoid getting infected in the first place by staying protected with internet security software like McAfee. Also, perform regular backups of all your data either online or to a separate external hard drive that is *only attached* to your computer while performing the backup. Ransomware has been known to lock access to external hard drives attached to the computer.

If you are infected with ransomware, think twice before you pay the ransom. There is no guarantee the cybercriminal will unlock your files and you'll be funding them to prey upon another innocent victim.

Botnets

A botnet is a string of infected, connected computers coordinated together to perform a task. Botnets gain access to your machine through some piece of malicious coding. Once the software is downloaded, the botnet will now contact its master computer and let it know that everything is ready to go. Now your computer, phone, tablet, or IoT device is entirely under the control of the person who created the botnet. Most people who are infected with botnets aren't even aware that their computer's security has become compromised!

What to do if you're infected: If you're infected you probably don't realize it as bots are notoriously quiet. Your Internet Service Provider might send you a notification alerting you that they found a threat on your network and that you need to remove the bot. If you have a bot, use

internet security software like McAfee to scan all of your devices.

Viruses/Malware

"Virus" is the commonplace word for all malicious software programs for years now; however, a virus is just one type of malicious threat. A virus is classified as a self-replicating piece of malicious code that travels by inserting itself into files or programs.

What to do if you're infected: Take steps to avoid infection by staying protected with internet security software like McAfee.

Take special precautions when using public Wi-Fi

Public Wi-Fi is available just about everywhere, from the local coffee shop to the hotels and airports you visit while traveling. While public Wi-Fi has made our lives a little easier, it also poses security risks to the personal information available on our laptops and smartphones. A virtual private network (VPN) gives you online privacy and anonymity by creating a private network from a public internet connection. VPNs mask your internet protocol (IP) address so your online actions are virtually untraceable as well as secure. One of the biggest security risks on public Wi-Fi are man-in-the-middle attacks (MITM). These attacks are akin to eavesdropping. Data is sent from point A [computer] to point B [server/website], and an attacker can get in-between these transmissions. They then set up tools programmed to "listen in" on transmissions, intercept data that is specifically targeted as valuable, and capture the data, such as your login credentials and passwords.

Use a virtual private network (VPN) to ensure your privacy and anonymity are protected when you use public Wi-Fi. VPN services can encrypt all the data that you send and receive while using a public Wi-Fi hotspot, securing your information from hackers and other users of the same connection.

For more tips on how to stay safe

Good security habits can reduce your exposure to online crime. By adopting a few basic behaviors, you can make big strides in reducing cybercrime risk:

- Protect your accounts with strong, unique passwords that use a combination of at least 10 uppercase and lowercase letters, symbols and numbers.
- Don't click on random links or open unsolicited messages and attachments—particularly from people you don't know.
- Don't access any personal information or social media accounts over unprotected Wi-Fi networks.
- Use security software on your devices to help protect yourself from the latest threats.

Protect your computer with Windows security tools

Windows provides a variety of protection applications.

Windows Updates

If you have an active internet connection, Windows can check for important updates for your computer and install them automatically. These updates include security patches and program updates that can improve your computing experience and help protect your computer against new viruses and attacks.