

IFP32 Series

Commercial Touch Display User Guide

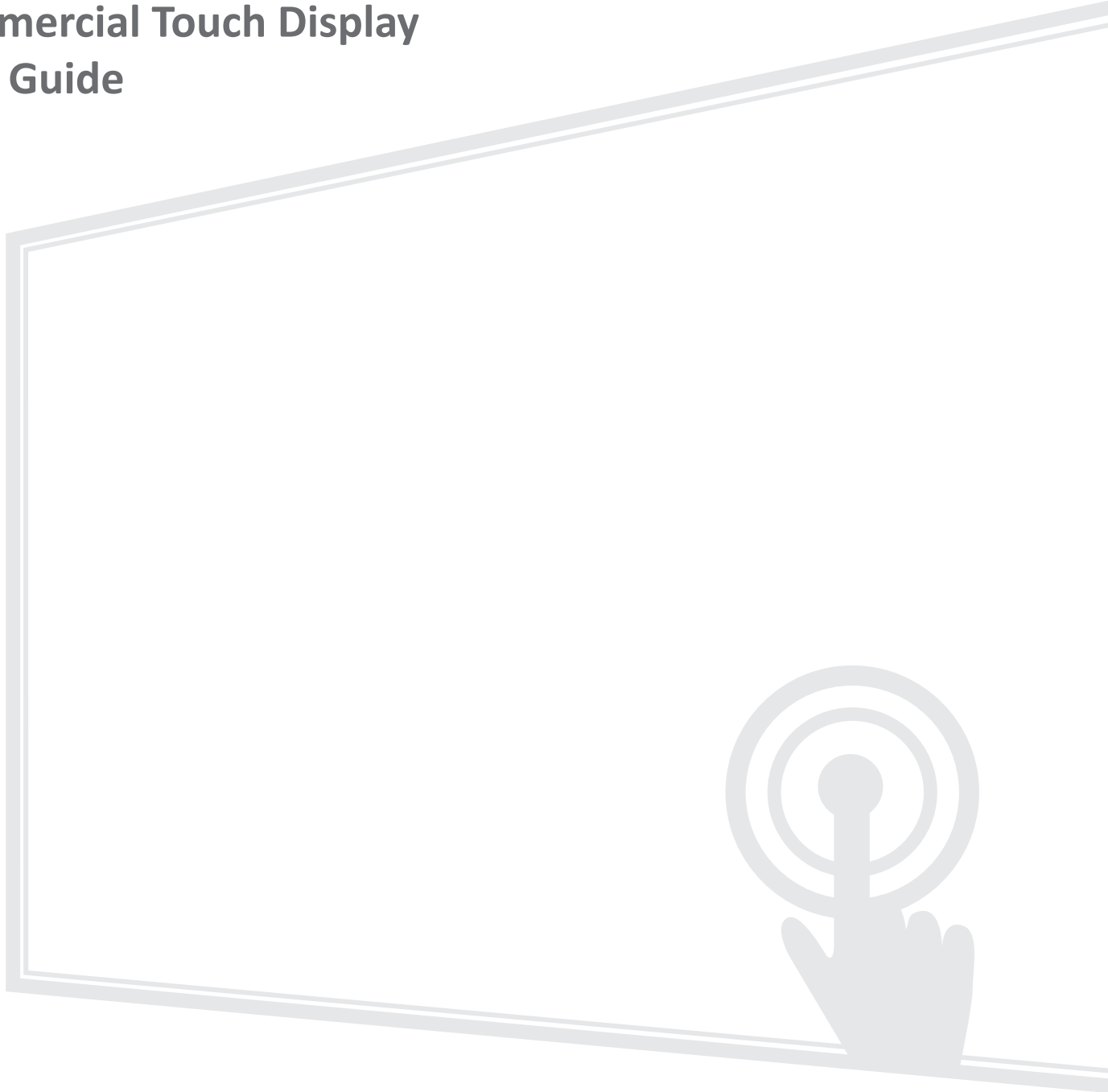

IMPORTANT: Please read this User Guide to obtain important information on installing and using your product in a safe manner, as well as registering your product for future service. Warranty information contained in this User Guide will describe your limited coverage from ViewSonic® Corporation, which is also found on our web site at <http://www.viewsonic.com> in English, or in specific languages using the Regional selection box in the upper right corner of our website. "Antes de operar su equipo lea cuidadosamente las instrucciones en este manual"

Model No. VS18471/VS18472/VS18473
P/N: IFP6532/IFP7532/IFP8632

Thank you for choosing ViewSonic®

As a world-leading provider of visual solutions, ViewSonic® is dedicated to exceeding the world's expectations for technological evolution, innovation, and simplicity. At ViewSonic®, we believe that our products have the potential to make a positive impact in the world, and we are confident that the ViewSonic® product you have chosen will serve you well.

Once again, thank you for choosing ViewSonic®!

Safety Precautions

Please read the following **Safety Precautions** before you start using the device.

- Keep this user guide in a safe place for later reference.
- Read all warnings and follow all instructions.
- Do not use the device near water. To reduce the risk of fire or electric shock, do not expose the device to moisture.
- Never remove the rear cover. This display contains high-voltage parts. You may be seriously injured if you touch them.
- Avoid exposing the device to direct sunlight or other sources of sustained heat.
- Do not install near any heat sources such as radiators, heat registers, stoves, or other devices (including amplifiers) that may increase the temperature of the device to dangerous levels.
- Use a soft, dry cloth to clean the external housing. For more information, refer to the "Maintenance" section on page 123.
- When moving the device, be careful not to drop or bump the device on anything.
- Do not place the device on an uneven or unstable surface. The device may fall over resulting in an injury or a malfunction.
- Do not place any heavy objects on the device or connection cables.
- If smoke, an abnormal noise, or a strange odor is present, immediately turn the device off and call your dealer or ViewSonic®. It is dangerous to continue using the device.
- The device is a monitor with an LED backlight intended for general office use.
- Do not attempt to circumvent the safety provisions of the polarized or grounding-type plug. A polarized plug has two blades with one wider than the other. A grounding-type plug has two blades and a third grounding prong. The wide blade and the third prong are provided for your safety. If the plug does not fit into your outlet, obtain an adapter and do not attempt to force the plug into the outlet.
- When connecting to a power outlet, DO NOT remove the grounding prong. Please ensure grounding prongs are NEVER REMOVED.
- Protect the power cord from being treaded upon or pinched, particularly at the plug, and at the point where it emerges from the equipment. Ensure that the power outlet is located near the equipment so that it is easily accessible.

- Only use attachments/accessories specified by the manufacturer.
- When a cart is used, use with caution when moving the cart/equipment combination to avoid injury from tipping over.
- Disconnect the power plug from the AC outlet if the device is not being used for a long period of time.
- Place the device in a well-ventilated area. Do not place anything on the device that prevents heat dissipation. Also, avoid any direct lighting.

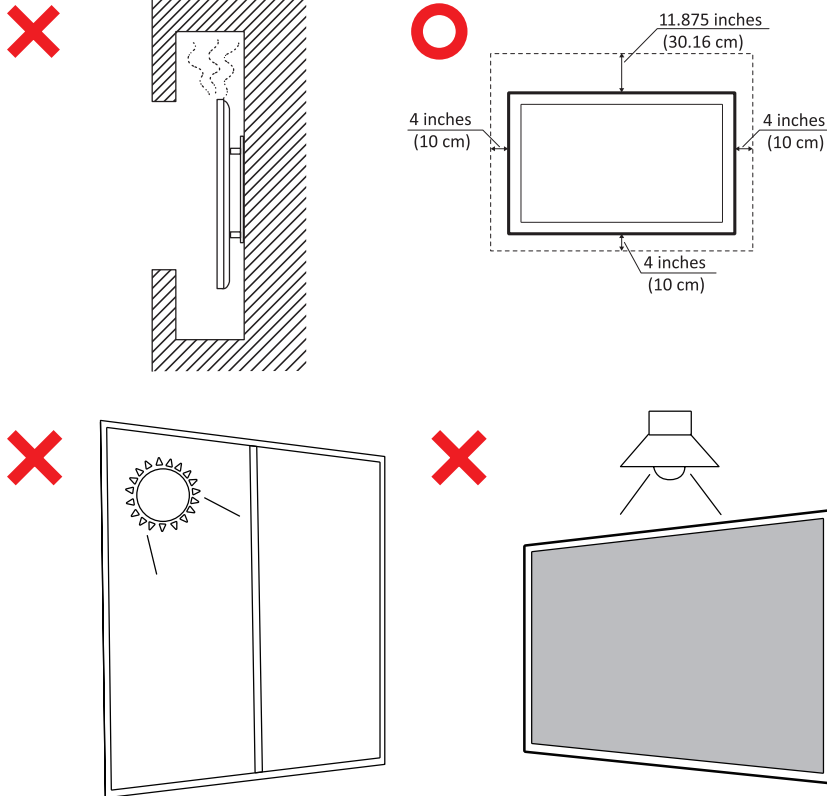

- Refer all servicing to qualified service personnel. Service will be required when the unit has been damaged in any way, such as:
 - » if the power supply cord or plug is damaged
 - » if liquid is spilled onto or objects fall in the unit
 - » if the unit is exposed to moisture
 - » if the unit does not operate normally or has been dropped

Contents

Safety Precautions	3
Introduction	9
Package Contents	9
Wall Mount Kit Specifications (VESA)	10
Product Overview	11
Front Panel Control Panel Rear Panel.....	11
I/O Panel.....	13
Remote Control	15
Using Gestures	19
Select and Deselect an Object (Clicking)	19
Display Menu Options (Right-Clicking)	19
Double-Clicking	19
Moving an Object	20
Erasing Digital Ink	20
Swipe Up for General Settings.....	20
Making Connections	21
Connecting External Devices and Touch Connection	21
HDMI Connection	21
VGA Connection	21
RS-232 Connection	22
USB and Networking Connections	23
Media Player Connection	24
Audio Connection.....	25

Using Your ViewBoard.....	26
Powering On/Off your ViewBoard.....	26
Initial Launch Setup	27
vLauncher - Customizable Welcome Screen.....	29
vLauncher Message.....	29
Applications.....	30
Toolbar	32
On-Screen Display (OSD) Menu	38
General Settings	39
Input Settings	40
Widget.....	41
Settings - HDMI & VGA Input Source.....	42
Audio Settings	42
Screen Settings.....	43
Display Settings	44
Low Blue Light Filter and Eye Health.....	45
Settings - Embedded Player.....	47
Wireless & Network	47
Wi-Fi	48
Ethernet	49
Wireless Hotspot.....	50
VPN.....	51
Share	53
SAMBA.....	53
Display	55
Wallpaper	56
Protection.....	58
Preference.....	59
Touch	60
Language	60
Keyboard & Input Method	61
Date & Time	62
Boot Mode	63
Startup & Shutdown.....	64
Toolbar Setting	65
Input Source	66

Rename Input Source	67
Source.....	68
App	69
APP	70
System	72
Clone to USB.....	73
Display ID.....	74
Security.....	75
System Update	78
About Device	79

Embedded Applications and Settings..... 80

Embedded Digital Whiteboarding App	80
myViewBoard	80
ViewBoard Cast	82
Cast Sender from Windows-based, Macbook, and Chrome devices.....	83
Cast Sender from Mobile Devices: iOS-based (iPhone, iPad) and Android OS based phone/tablet.	84
Cast Out from a Mobile Device that Supports Annotation	85
Screen Recorder	86
Air Class	87
Voter	89
Judge	91
Responder	92
Selector	93
Grouping.....	93
Message	94
Manager.....	94
Exit.....	94
Other Default Applications	95
vSweeper.....	95
Screen Lock	96
Chromium.....	97
WPS Office.....	97
Folders.....	98

RS-232 Protocol	100
Description	100
RS-232 Hardware Specification	100
LAN Hardware Specification.....	101
RS232 Communication Setting.....	101
LAN Communication Setting	101
Command Message Reference.....	101
Protocol	102
Set-Function Listing.....	102
Get-Function Listing	108
Remote Control Pass-through Mode	116
Appendix	119
Specifications.....	119
Display Modes	120
VGA Mode	120
HDMI Mode.....	120
Troubleshooting	121
Maintenance.....	123
General Precautions.....	123
Cleaning the Screen.....	123
Cleaning the Case	123
Regulatory and Service Information	124
Compliance Information.....	124
Industry Canada Statement.....	124
CAN ICES-3 (B)/NMB-3(B).....	124
CE Conformity for European Countries	124
Declaration of RoHS2 Compliance.....	125
Indian Restriction of Hazardous Substances	126
Product Disposal at End of Product Life	126
Copyright Information	127
Customer Service	128
Limited Warranty	129

Introduction

Package Contents

- HDMI cable (3m)
- Power cable (ship by region)
- Remote control
- AAA battery x 2
- USB cable for touch control (3m)
- Touch Pen x 2
- Quick Start Guide
- Wall mount screws x 4

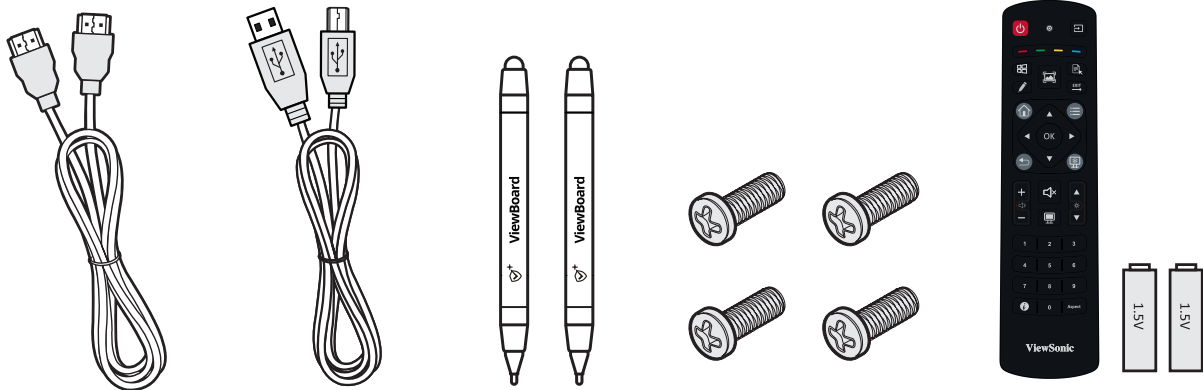
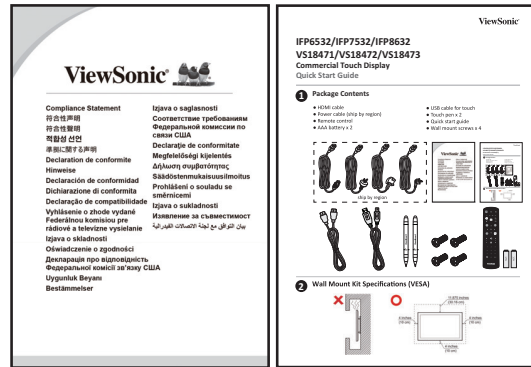
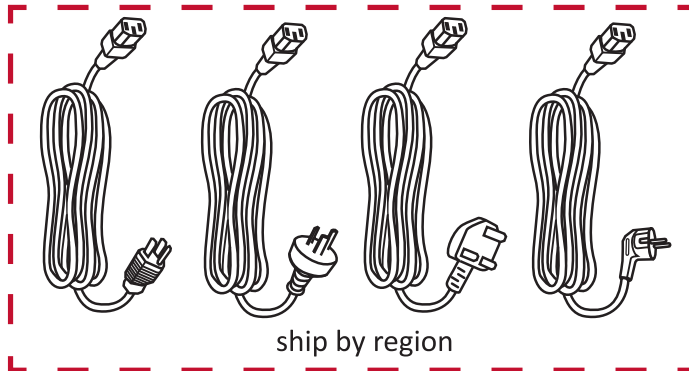

NOTE: The power cord and video cables included in your package may vary depending on your country. Please contact your local reseller for more information.

Wall Mount Kit Specifications (VESA)

NOTE: Please follow the instructions in the wall mount installation guide to install your wall mount or mobile mount bracket. If attaching to other building materials, please contact your nearest dealer.

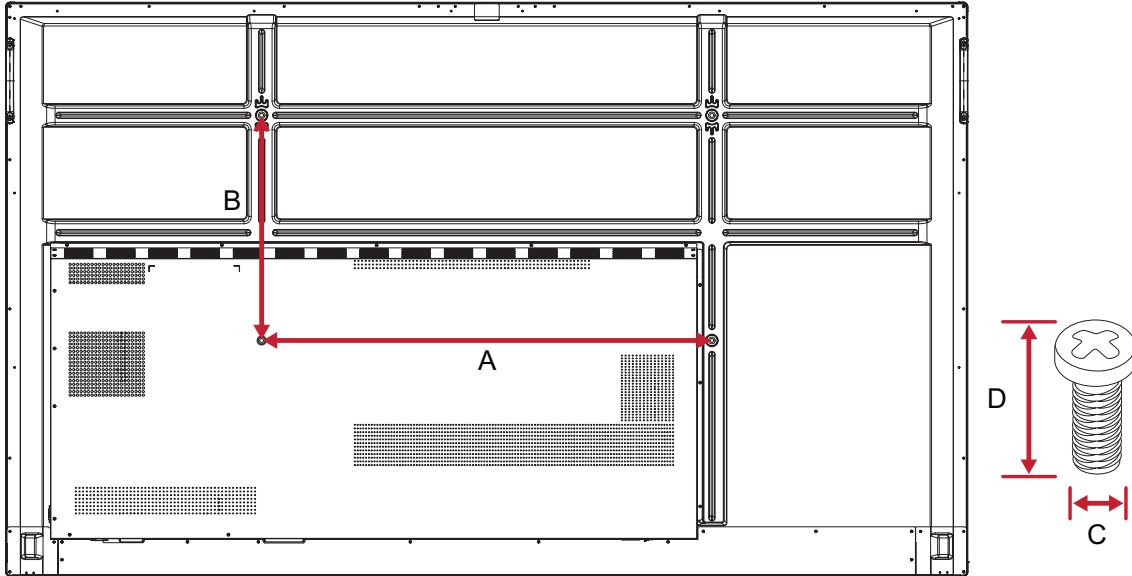



Model	VESA Spec. (A x B)	Standard Screw (C x D)	Quantity
IFP6532 - 65"	600 x 400 mm	M8 x 25 mm	4
IFP7532 - 75"	800 x 400 mm	M8 x 25 mm	4
IFP8632 - 86"	800 x 600 mm	M8 x 25 mm	4

NOTE: Do not use screws that are longer than the standard dimension, as they may cause damage to the inside of the display.

Product Overview

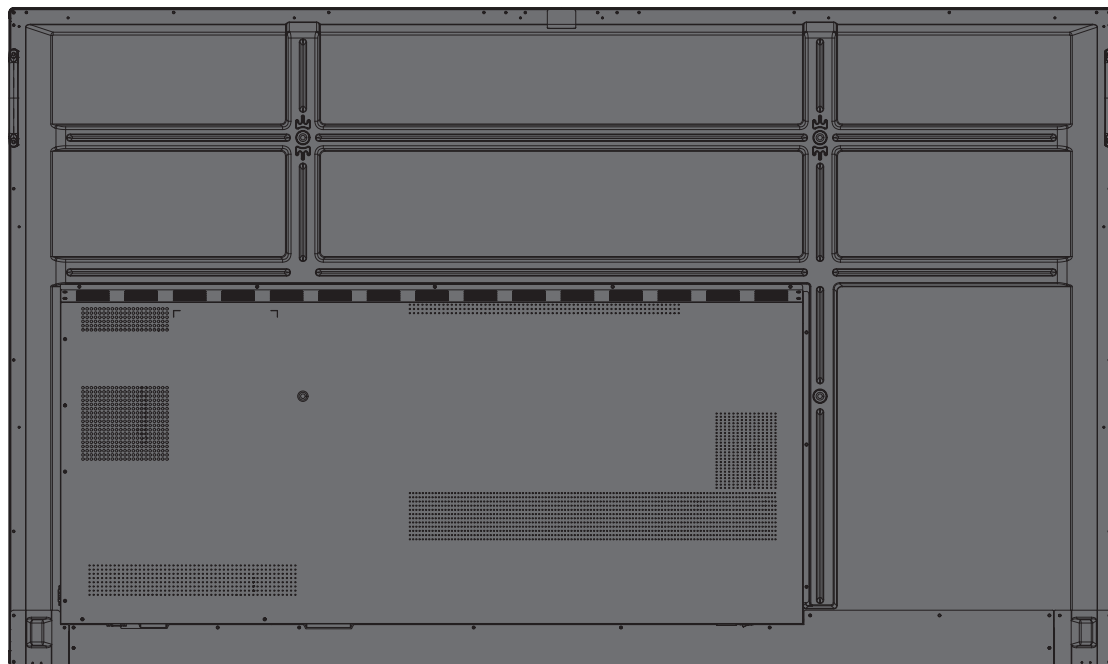
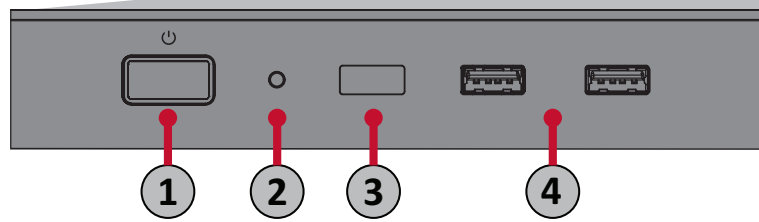
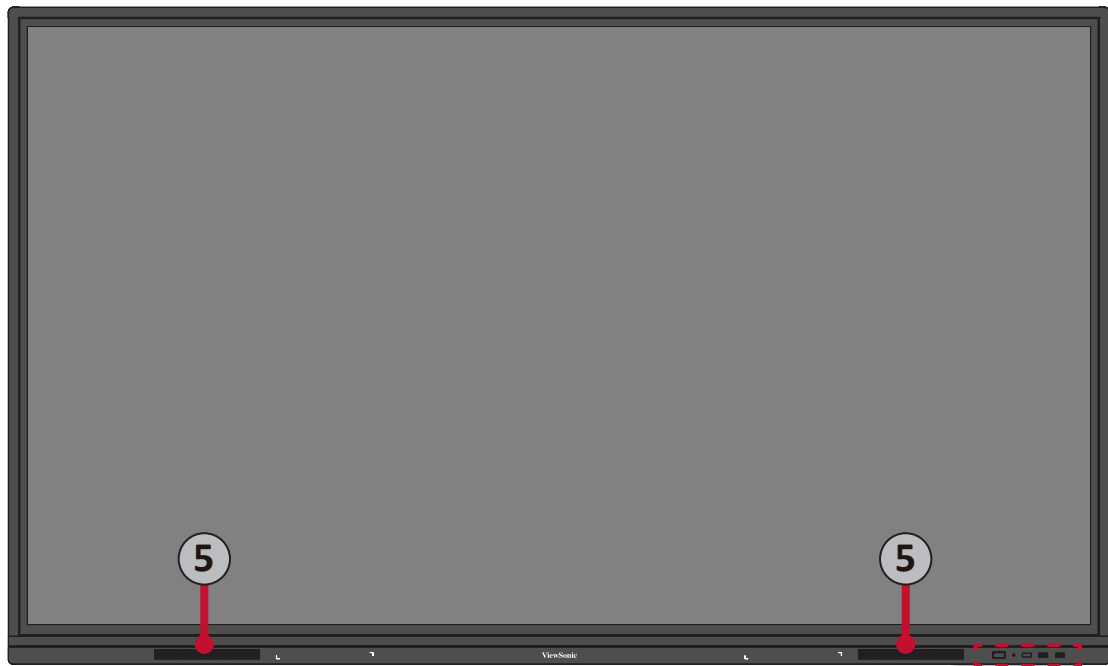
Front Panel | Control Panel | Rear Panel

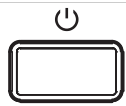

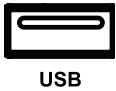
Number	Item	Description
1		<p>Power button</p> <ul style="list-style-type: none"> • Turn on/off the device • Tap to enter Energy Saving mode • Press and hold for at least two (2) seconds to enter Standby mode
2		Ambient light sensor
3		Remote control IR sensor
4		USB 2.0. Smart USB port for PC, HDMI, VGA, and ViewBoard input signals.
5		Speaker

I/O Panel

Lower Right Side

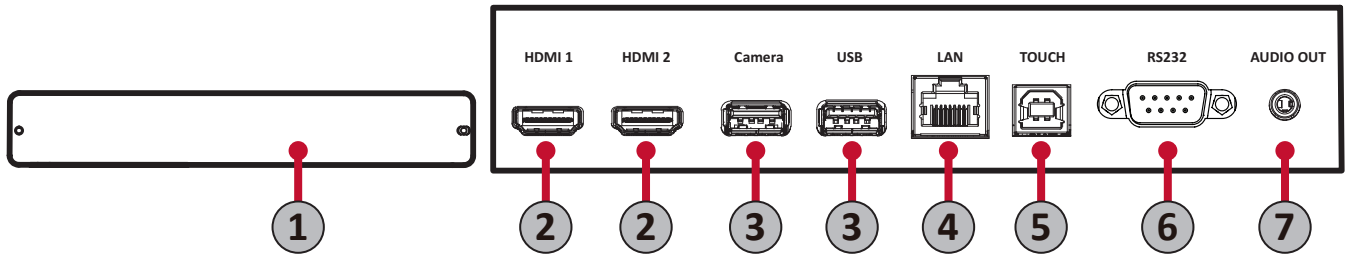

Bottom Left

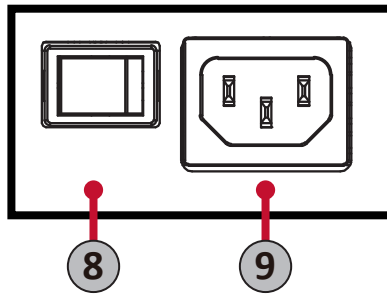

Bottom Right

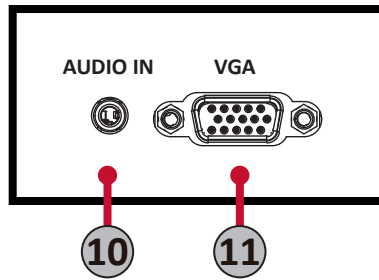

Bottom Center

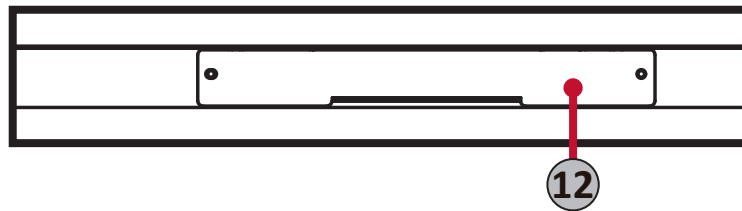

Number	Port	Description
1	PC Slot	Slot for adding optional PC module.
2	HDMI 1/2	High definition input; connect to PC with HDMI output, set-top box, or other video device.
3	USB 2.0	Connect USB devices such as hard disks, keyboard, mouse, etc. [5V dc/0.5A]
4	LAN	Standard RJ45 (10M/100M for PC; 10M/100M for ViewBoard) Internet connection interface. NOTE: This network port is used for the Embedded Player and slot-in PC.
5	Touch	Touch signal output to external PC.
6	RS-232	Serial interface; used for mutual transfer of data between devices.
7	Audio Out	Audio output to an external speaker.
8	AC Switch	Turn on/off AC power supply "I" = Power on, "O" = Power off
9	AC IN	AC power input.
10	Audio In	External computer audio input.
11	VGA	External computer video input.
12	Wi-Fi Module Slot	Slot for adding optional Wi-Fi module (VB-WIFI-002).

Remote Control

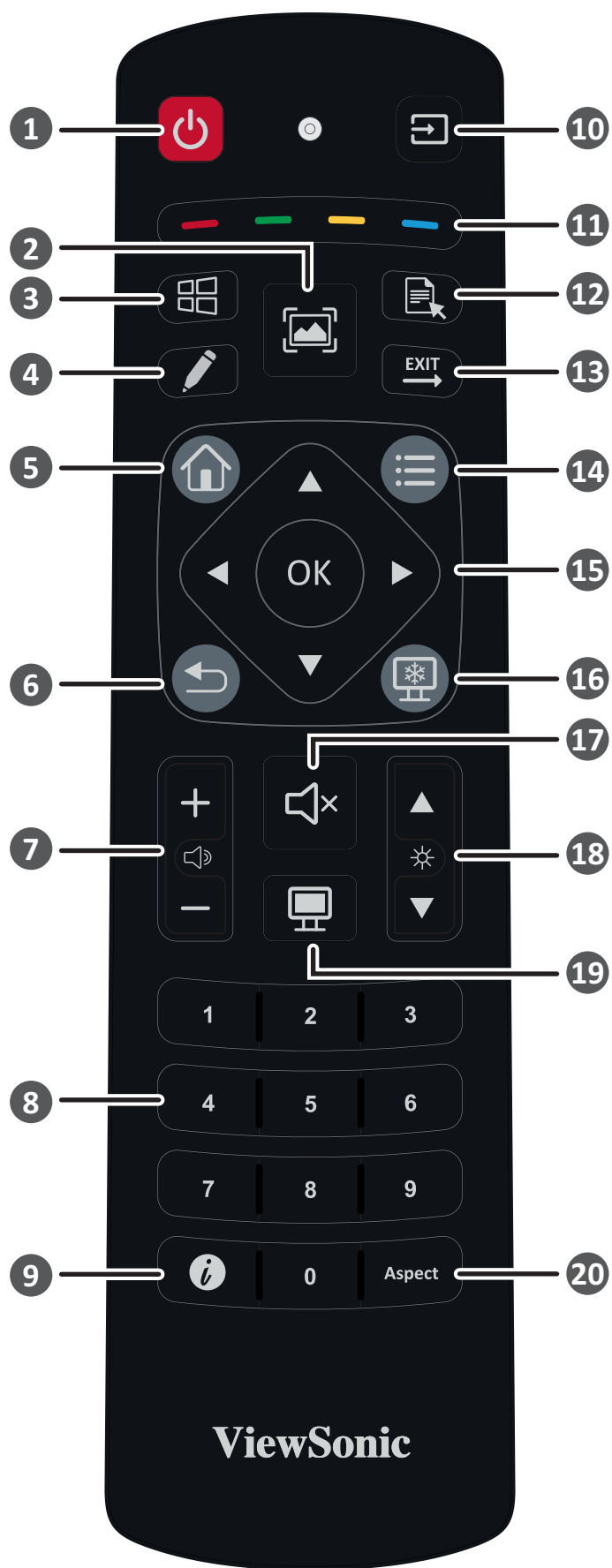

Number	Description
1	Power on/off
2	Screen capture
3	[PC ¹] <i>Windows</i> button
4	Startup writing
5	Back to the Embedded player Home Screen
6	Back / Return to previous page
7	Increase / Decrease volume
8	Numeric Keypad
9	Information
10	Input source selection
11	Media control buttons: » Red - Play / Pause » Green - Stop » Yellow - Forwards » Blue - Backwards
12	[PC ¹] <i>Menu</i> button
13	[PC ¹] Exit dialog box
14	Settings menu
15	Up / Down / Left / Right OK
16	Freeze screen
17	Mute / Unmute
18	Increase / Decrease Brightness
19	Blank screen
20	Adjust Aspect Ratio

¹ All computer-related function keys are not available without a slot-in computer.

Inserting Remote Control Batteries

To insert batteries into the remote control:

1. Remove the cover on the rear of the remote control.
2. Insert two “AAA” batteries, ensuring the “+” symbol on the battery matches the “+” on the battery post.
3. Replace the cover by aligning it with the slot on the remote control and snapping the latch shut.

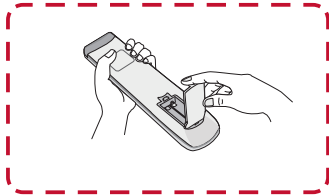

(1)

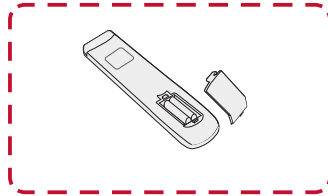

(2)



(3)

WARNING: There is a risk of explosion if batteries are replaced with the incorrect type.

NOTE:

- It is recommended that you do not mix battery types.
- Always dispose of old batteries in an environmentally friendly way. Contact your local government for more information on how to dispose of batteries safely.

Remote Control Receiver Range

The working range of the remote control is shown here. It has an effective range of 8 meters, 30° degrees left and right. Ensure there is nothing obstructing the remote control's signal to the receiver.

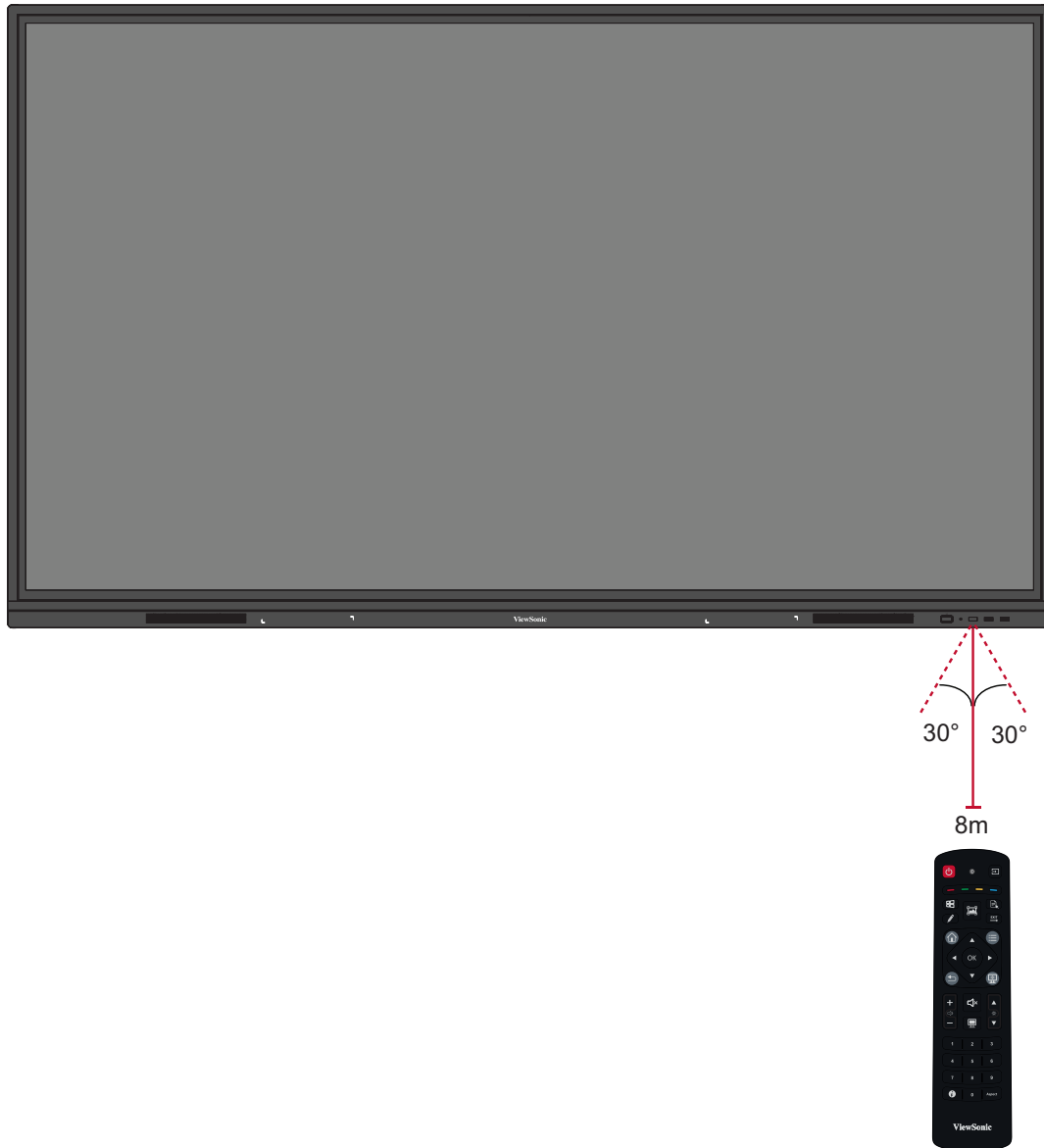

Using Gestures

Touch gestures allow the user to use pre-determined commands without using a keyboard or mouse. Using gestures on the ViewBoard, the user can select/deselect objects, change the location of an object, access settings, erase digital ink, and much more.

Select and Deselect an Object (Clicking)

Press and release the ViewBoard to select/deselect options or objects. This is like a single, standard left mouse click.

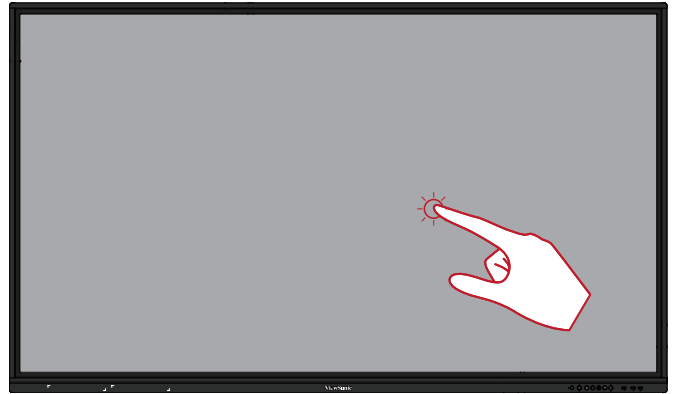

Display Menu Options (Right-Clicking)

Press and hold the ViewBoard with your finger. This is like a single, standard right mouse click.



Double-Clicking

Quickly press and release twice in the same location on the ViewBoard. This is like a double, standard left mouse click.

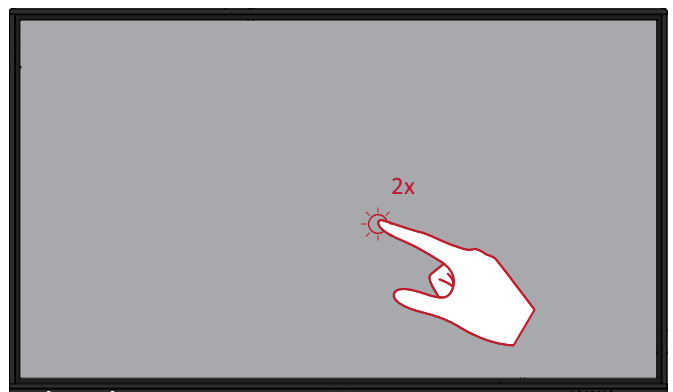

Moving an Object

Press and hold the object on the ViewBoard and slowly drag it with your finger to your desired location.

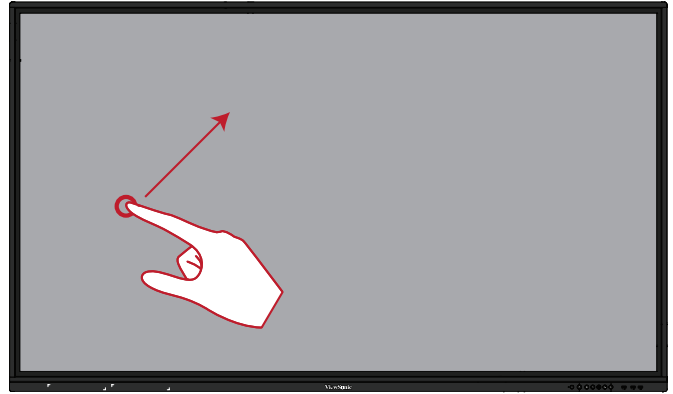

Erasing Digital Ink

Use your flattened hand, palm, or fist on the ViewBoard and move your hand across the area which you wish to erase.

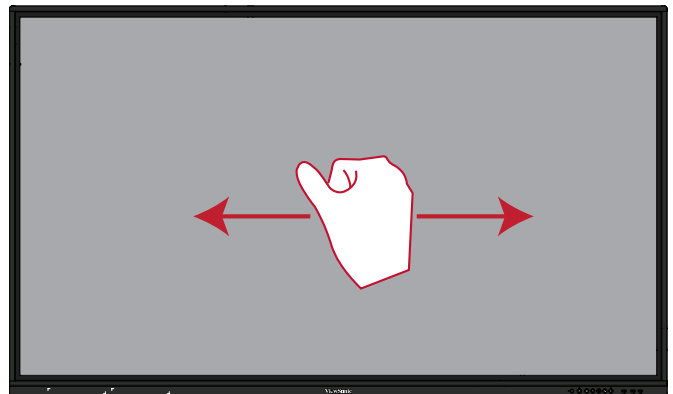

Swipe Up for General Settings

Swipe up from the bottom of the ViewBoard to launch the General Settings.

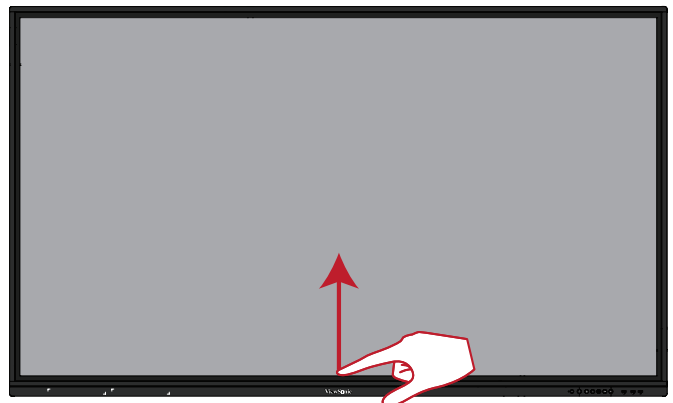

Making Connections

Connecting External Devices and Touch Connection

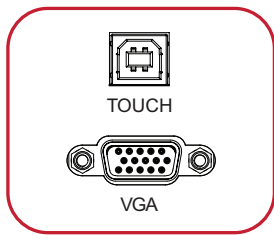

or

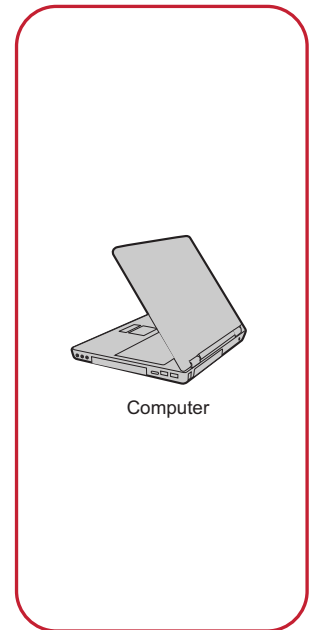
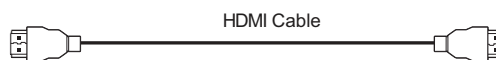
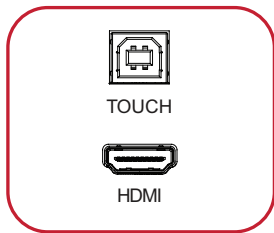

Your external device(s) can be connected in any of the following configurations:

HDMI Connection

To connect via HDMI:

1. Connect an HDMI cable from your external device to the **HDMI** port on the ViewBoard.
2. Connect a USB cable to the external device from the **TOUCH** port of the ViewBoard.

VGA Connection

To connect via VGA:

1. Connect a VGA cable from your external device to the **VGA** port on the ViewBoard.
2. Connect a USB cable to the external device from the **TOUCH** port of the ViewBoard.

RS-232 Connection

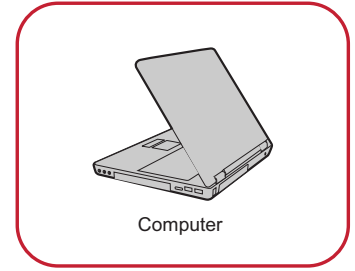
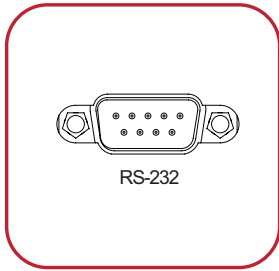

When you use a RS-232 serial port cable to connect your display to an external computer certain functions can be controlled remotely by the PC, including Power On/Off, Volume adjustment, Input select, Brightness, and more.

USB and Networking Connections

Just like any PC, it is easy to connect various USB devices and other peripherals to your ViewBoard.

USB Peripherals

Plug the USB device cable into the **USB** port.

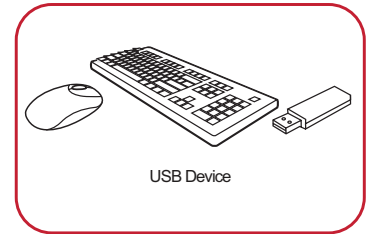
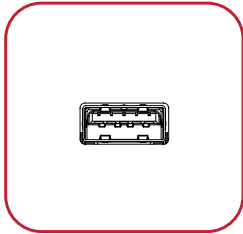

Networking and Modem cables

Plug the network cable into the **LAN** port.

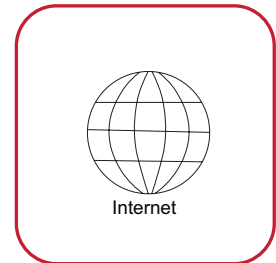
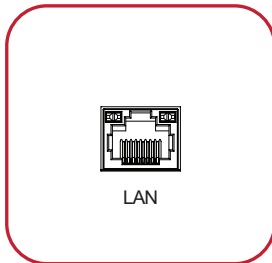

Media Player Connection

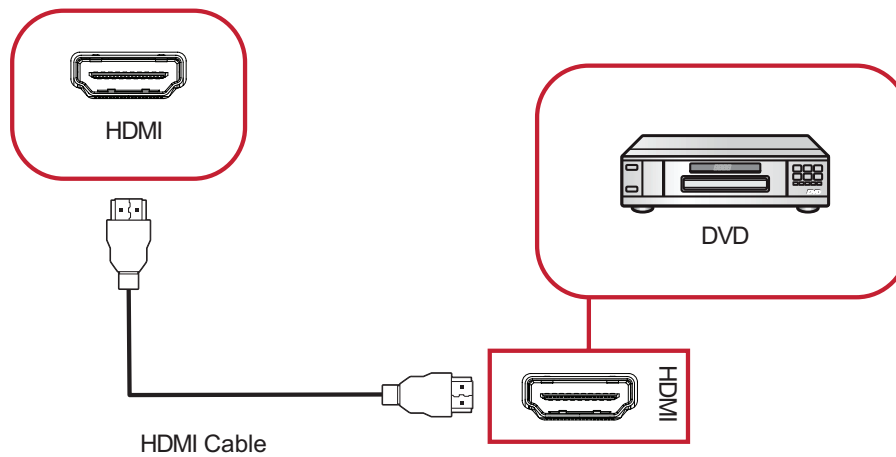

To connect to a media player:

1. Connect the HDMI cable to the **HDMI** ports on your ViewBoard and peripheral device.
2. Plug in the power cord of your ViewBoard, and turn on the power supply switch.
3. Press the **Power** button on the right-hand side of the ViewBoard to turn the screen on.
4. Press the **INPUT** button on the remote control and switch to the “HDMI” input source.

Audio Connection

The ViewBoard supports both **Audio In** and **Audio Out**.

Audio In

To play audio from your external device through the ViewBoard's speakers, connect one end of an audio cable to your external device, and the other end to the ViewBoard's **Audio In** port.

Audio Out

To play audio from the ViewBoard through an external speaker, connect one end of an audio cable to the external speaker, and the other end to the ViewBoard's **Audio Out** port.

Using Your ViewBoard

Powering On/Off your ViewBoard

1. Ensure the power cord is connected, plugged into a power outlet, and the power switch is in the “On” position.



The AC Power input and switch are located at the bottom of the unit.

2. Press the **Power** button to turn on the ViewBoard.
3. To turn the ViewBoard off, press and hold the **Power** button.

Initial Launch Setup

When you first turn on your ViewBoard, an initial setup wizard will launch.

1. Select your Language:

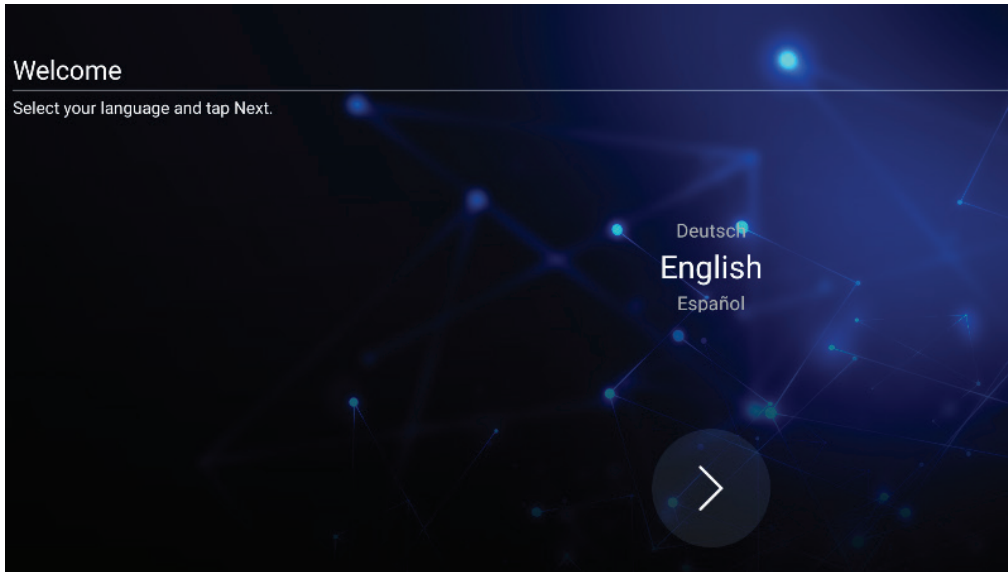

2. Setup and verify your LAN connection:

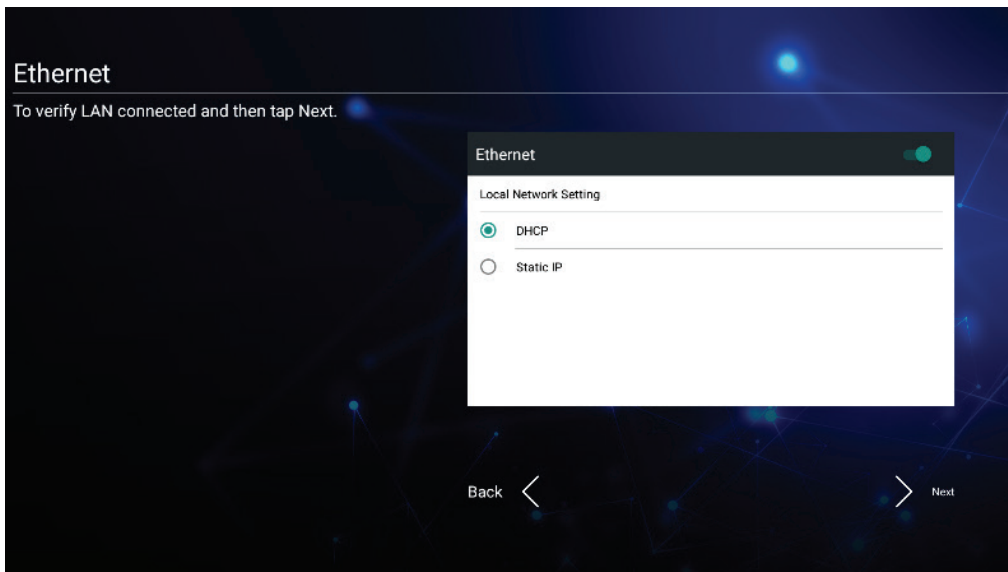

3. Select your Time Zone to set the Date and Time:

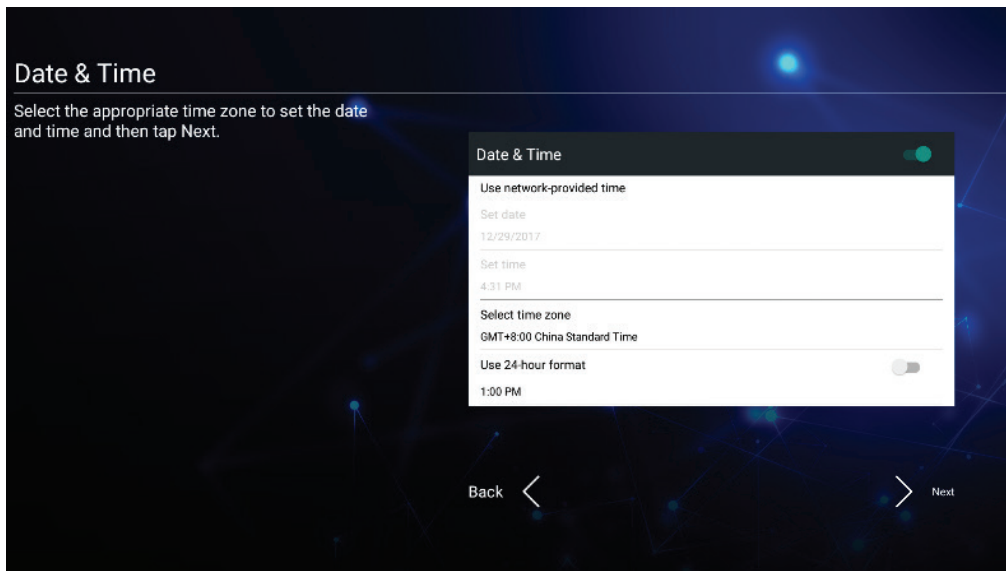

4. Select your preferred System Mode:

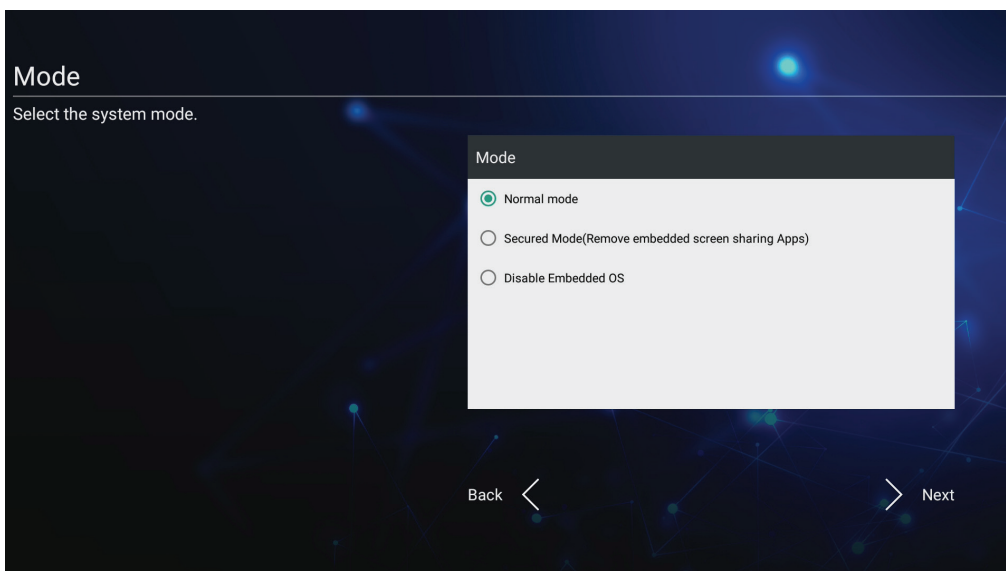

5. Accept or Decline the Privacy and Copyright Protection Terms.

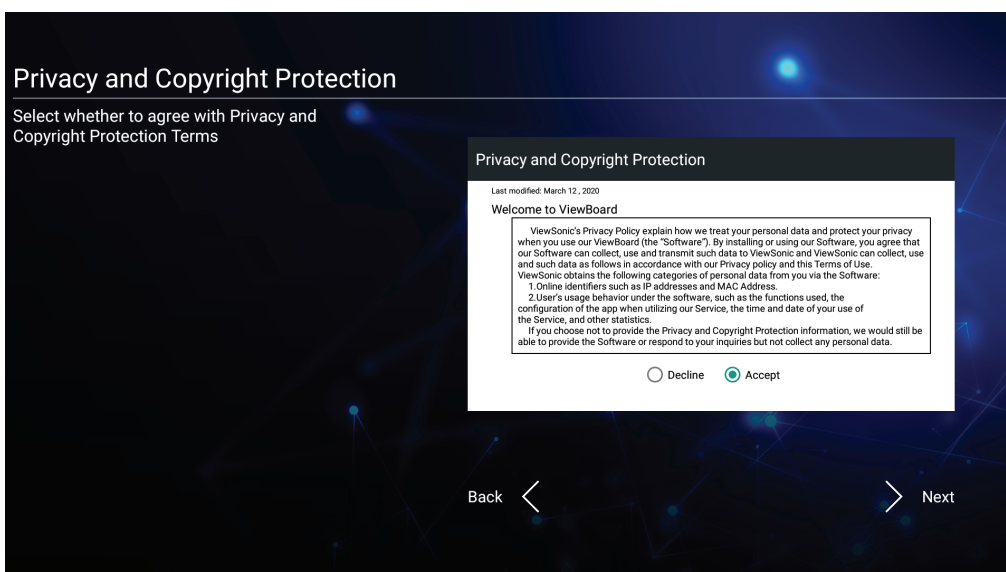

vLauncher - Customizable Welcome Screen

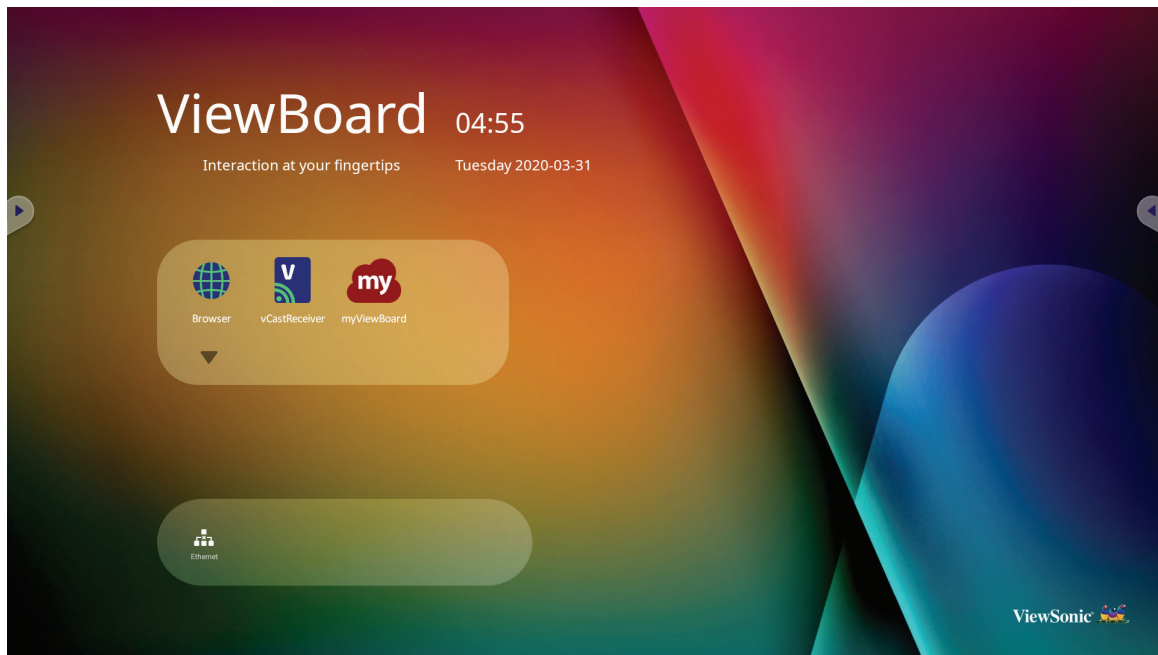

vLauncher Message

Both the vLauncher **Title** and **Subtitle** can be customized by tapping on them.



Additionally, a password can be set by tapping on **Set Password**.

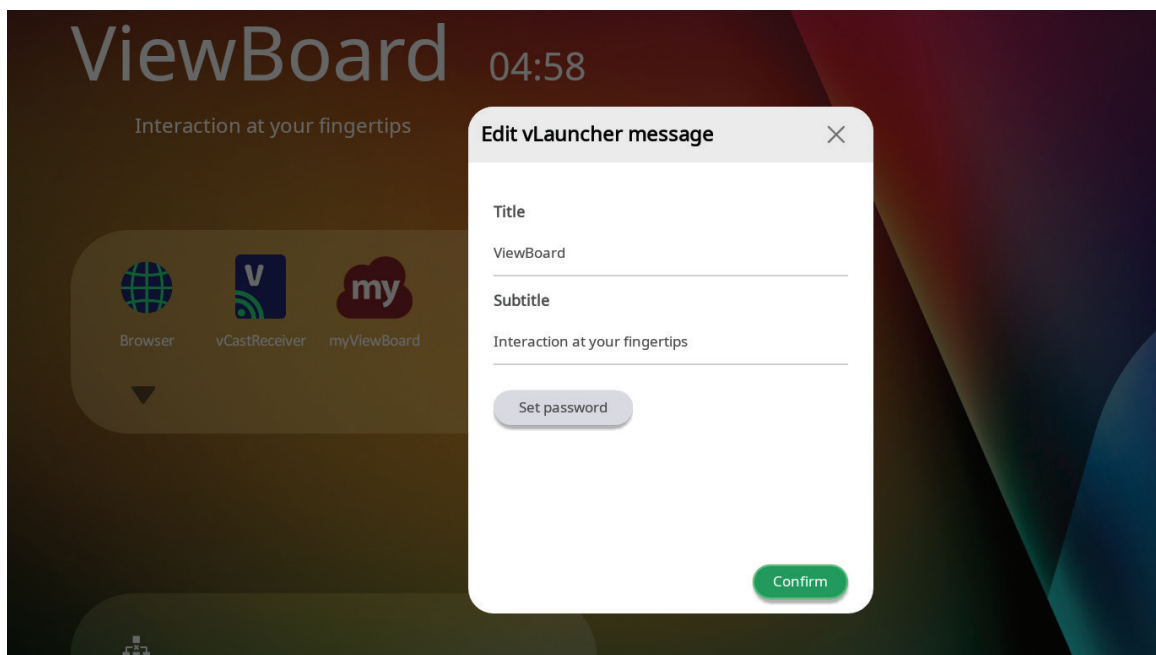

Applications

Installed applications can all be found on the welcome screen. To view all applications tap on the **Down Arrow**.

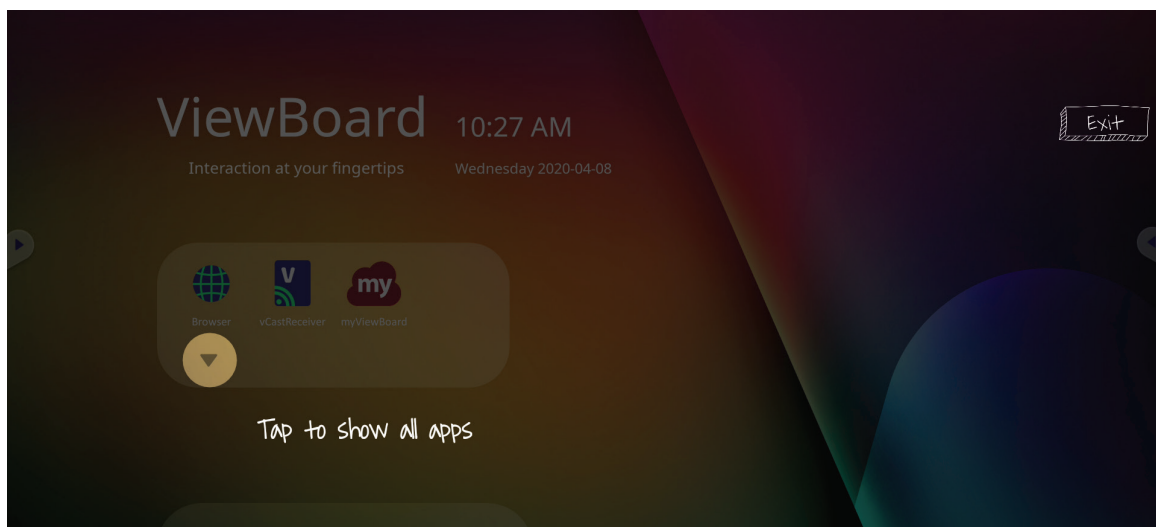

To hide the application drawer tap the **Up Arrow**.

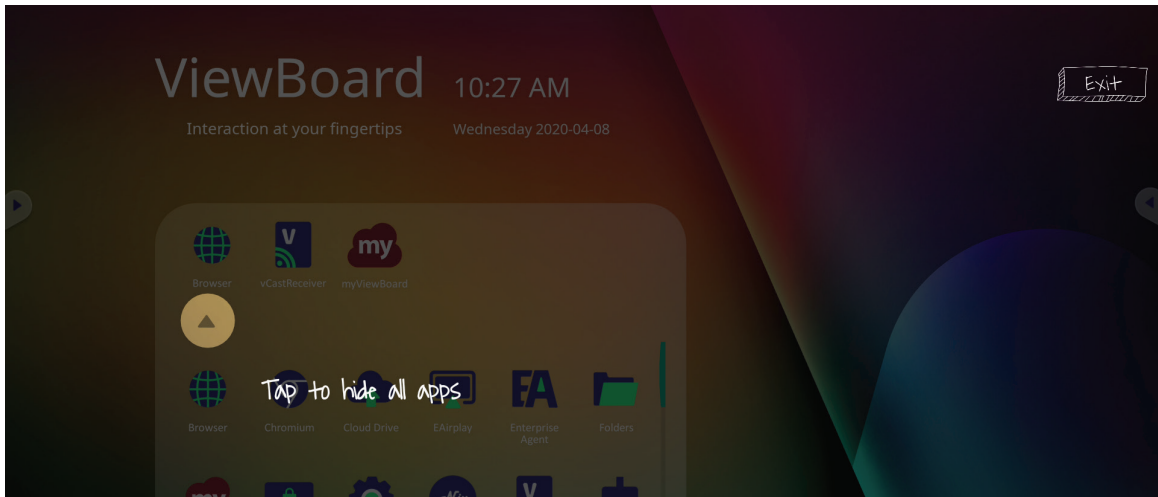

To add a shortcut to an application, tap, hold, and drag up the icon.

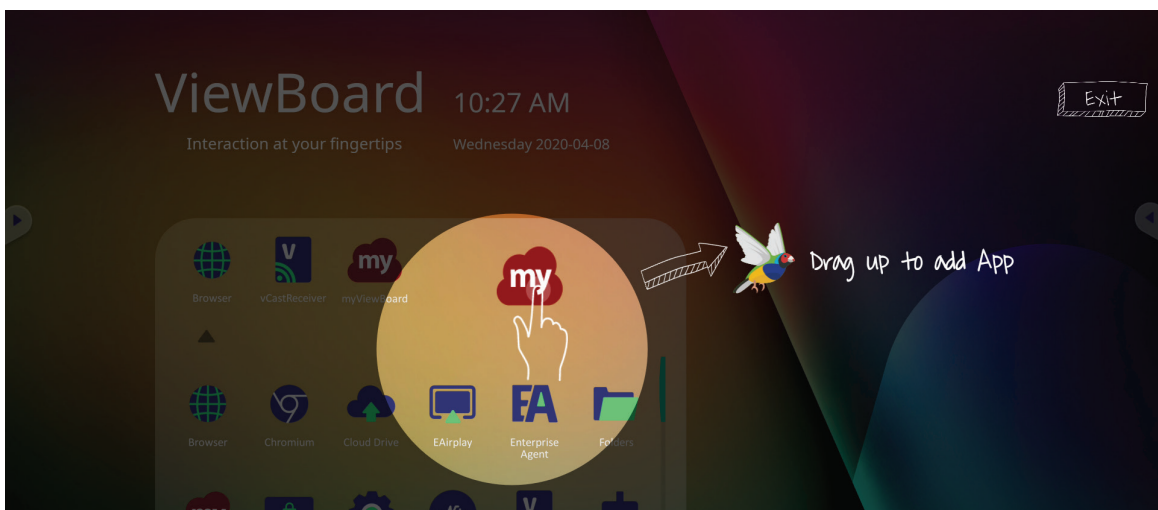

To remove an application shortcut, tap, hold, and drag the icon down.

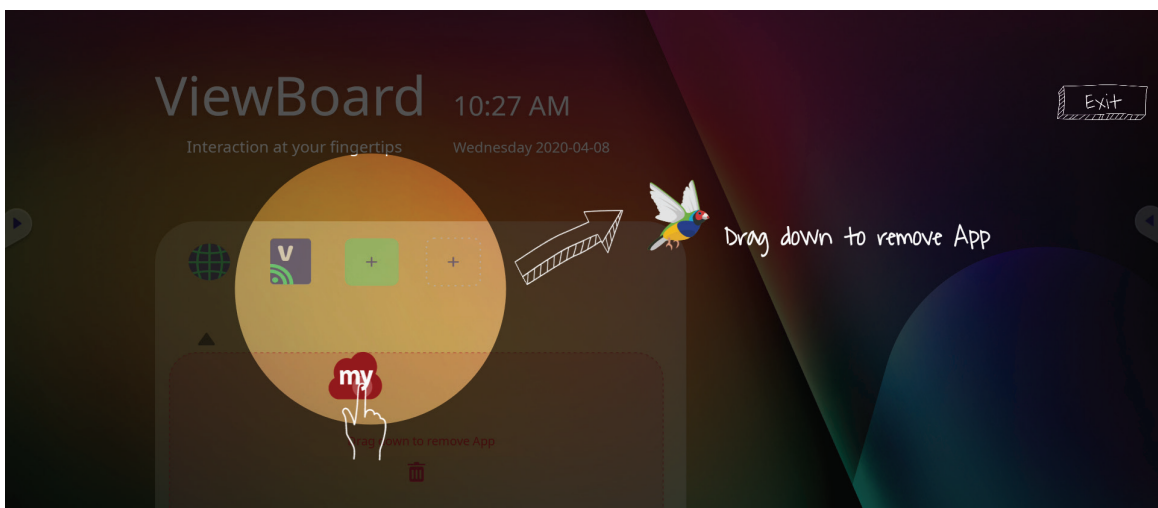

Toolbar

Toolbar trigger icons are on the edge of the ViewBoard launcher providing access to your tools.

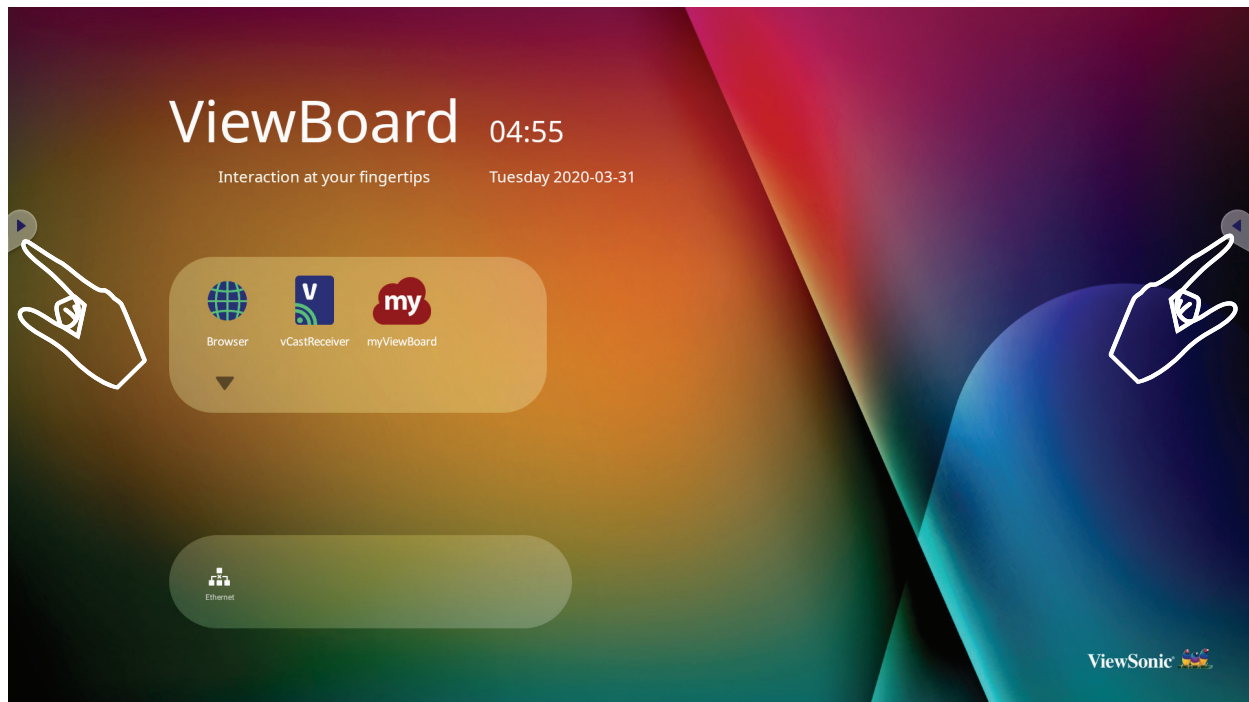





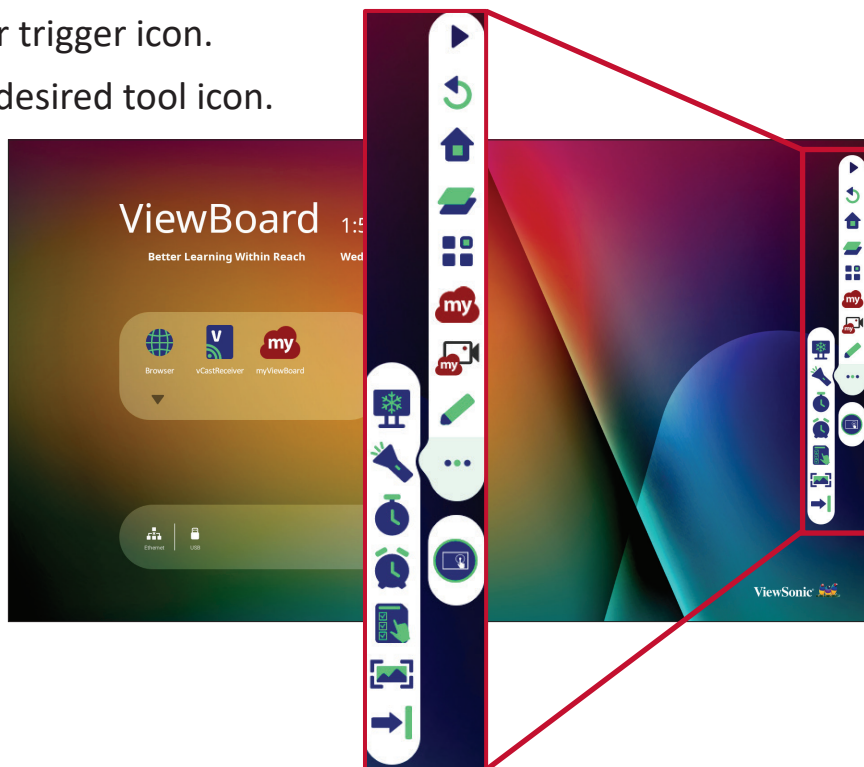









To launch a tool:





1. Tap a Toolbar trigger icon.
2. Tap on your desired tool icon.



NOTE: The default toolbar setting is to be available for all input sources; however, users can go to: **Settings > Preference > Toolbar setting** to adjust the options: (1) available for all input sources, (2) hide the toolbar for all input sources.

Icon	Description
 Back	Return to the previous operation screen. NOTE: Only for the Embedded Player source.
 Home	Return to the Home Screen of the Embedded Player.
 Recent	Display all embedded applications that are currently being used.
 App	View all installed applications.
 myViewBoard	Launch the myViewBoard software.
 Recorder	Record, view, and save the on-screen content.

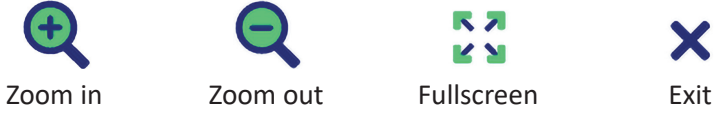
Icon	Description
 Draw	<p>Access the pen, highlighter, clear, and save options.</p> <div style="display: flex; justify-content: space-around; align-items: center;"> <div style="text-align: center;">  Pen </div> <div style="text-align: center;">  Highlighter </div> <div style="text-align: center;">  Eraser </div> <div style="text-align: center;">  Undo </div> </div> <div style="display: flex; justify-content: space-around; align-items: center; margin-top: 10px;"> <div style="text-align: center;">  Redo </div> <div style="text-align: center;">  Clean </div> <div style="text-align: center;">  Save </div> <div style="text-align: center;">  Exit </div> </div>
	<p><u>Pen</u></p> <p>Annotate the overlay of any input source with black, white, yellow, orange, red, pink, green, or blue ink.</p> <p>NOTE: The default pen setting supports up to 10-point writing.</p>
	<p><u>Highlighter</u></p> <p>Mark and highlight with yellow, grey, gold, orange, red, pink, green or blue ink.</p> <p>NOTE: The default highlighter setting supports up to 10-point marking.</p>
	<p><u>Eraser</u></p> <p>Selectively remove the digital ink on the screen.</p>
	<p><u>Undo</u></p> <p>Undo the previous action.</p>
	<p><u>Redo</u></p> <p>Redo the previous action.</p>
	<p><u>Clean</u></p> <p>Clears all the digital ink on the screen.</p>
	<p><u>Save</u></p> <p>Save the screen image and any annotations.</p>
	<p><u>Exit</u></p> <p>Close the drawing tool.</p>

Icon	Description
	<p>View more applications within the ViewBoard tool bar.</p>  <p>Screen Freeze Spotlight Stopwatch Timer Air Class Hide/Unhide Screen Capture</p>
	<p><u>Screen Freeze</u> </p> <p>Convert the currently displayed content into a still image; then you can zoom in, zoom out, go back to full screen, and exit.</p>  <p>Zoom in Zoom out Fullscreen Exit</p>
	<p><u>Spotlight</u> </p> <p>Highlight the focus content zone. Tap the Setting icon to adjust the spotlight size and alpha blending effect.</p> 

Icon

Description

Stopwatch 

Tapping **Start** will initiate the stopwatch.

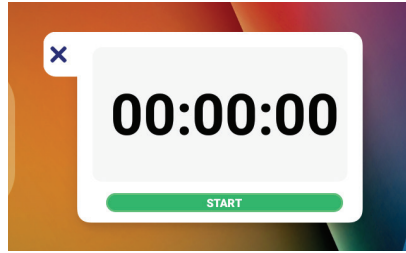

At any time, the stopwatch can be paused, resumed, split, or reset.

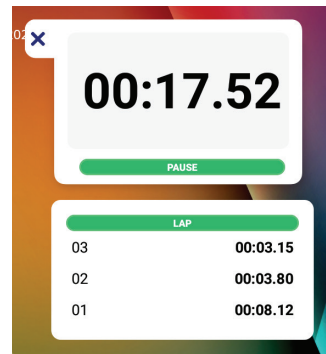
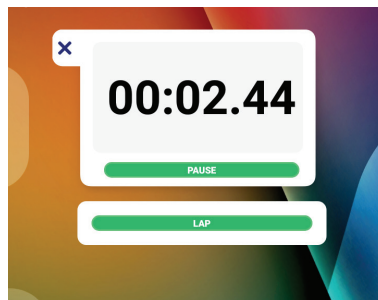

More

Timer 

Access the countdown timer with an optional alarm setting. Touch and swipe to adjust the numeric values, then click **Start**.

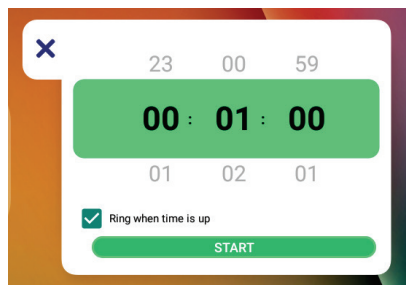



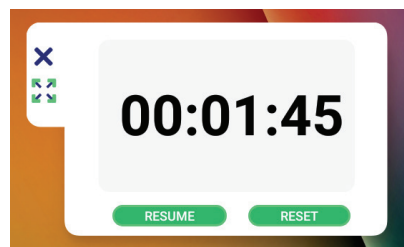
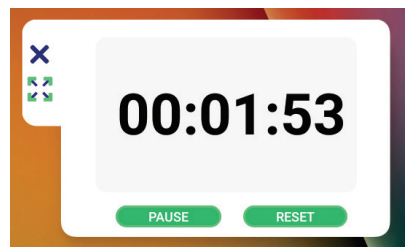

At any time, the countdown timer can be paused, resumed, or reset.



Hide/Unhide  

Hide or unhide the Tool bar trigger icons.

Icon	Description
 More	<p><u>Air Class</u> </p> <p>Interactive teaching tool for classroom usage.</p> <p><u>Screen Capture</u> </p> <p>Take a screenshot of the current screen.</p>
 Settings	<p>Access the General Settings.</p>

On-Screen Display (OSD) Menu

Access General Settings, Input Settings, and Widgets through the OSD Menu.

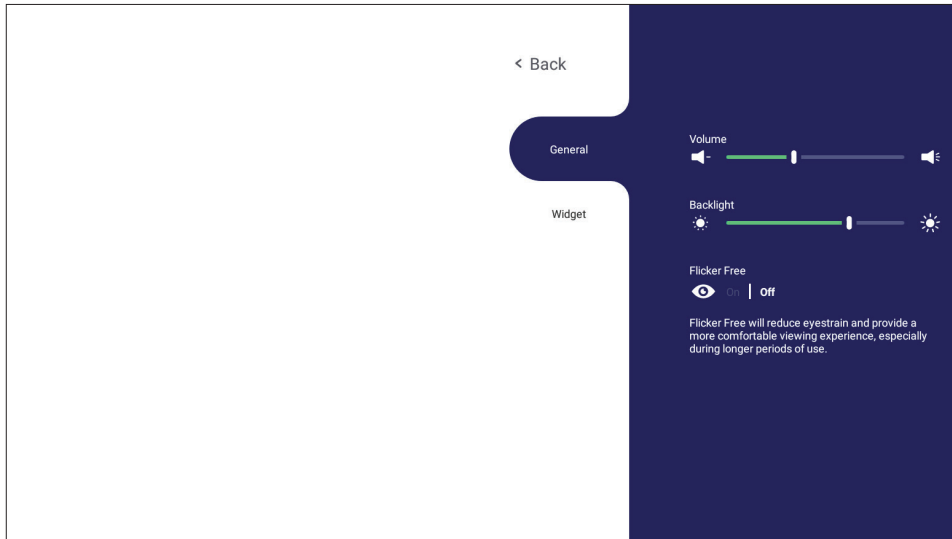

ViewBoard has two options for opening the OSD Menu:

Option 1

Long press anywhere in the vLauncher background.

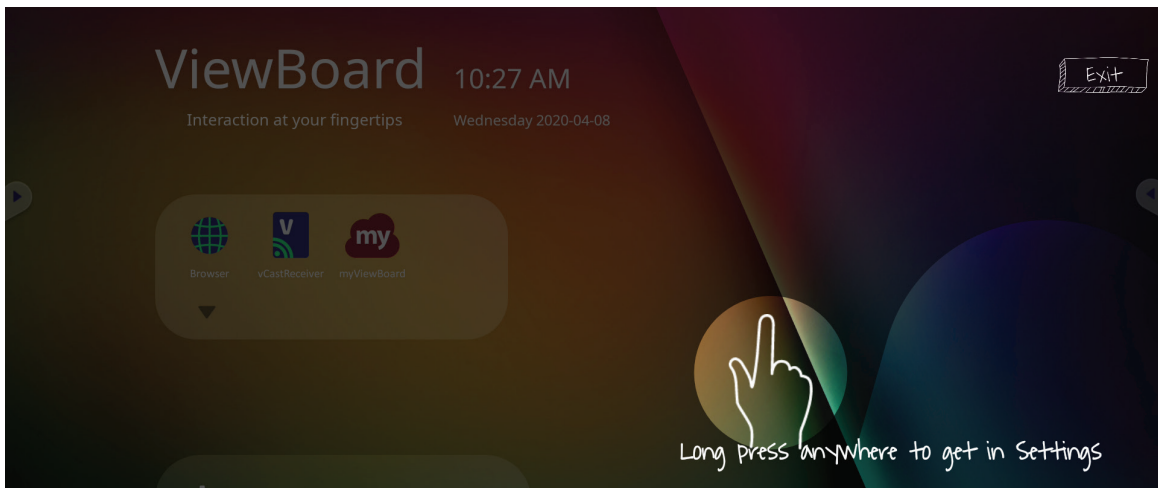

Option 2

Press the **INPUT** button on the remote control.

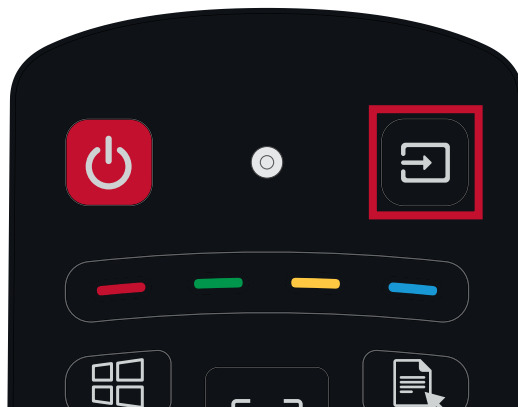

General Settings

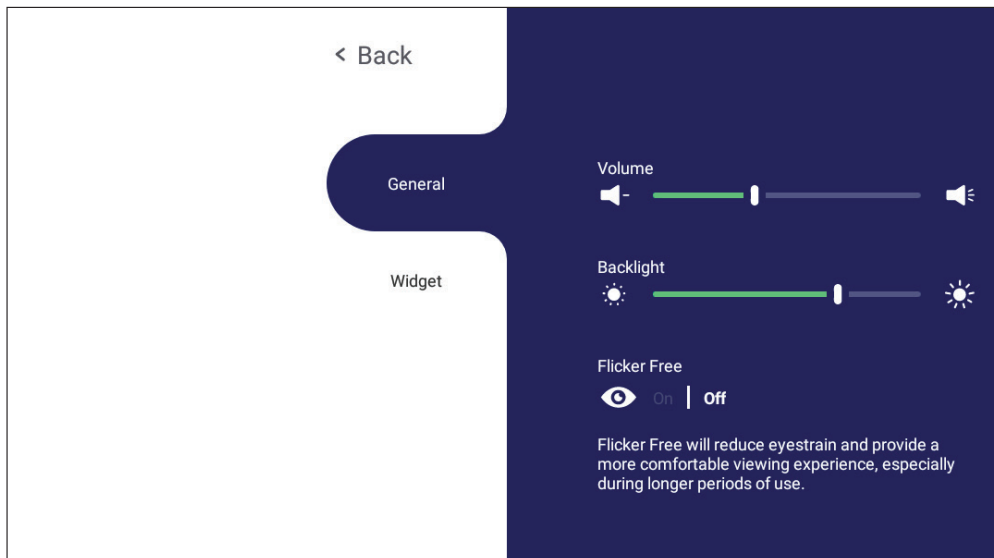

To adjust the Backlight and enable/disable Flicker Free:

1. Press **INPUT** on the remote control or long press the vLauncher background and touch **General** on-screen (if needed) to display the **General Settings** menu.
2. Drag the brightness slider directly to adjust the backlight value, and/or touch On or Off to enable/disable the function.
3. Press **BACK** on the remote control, or touch a blank area outside of the menu to exit.





To adjust the Volume:

1. Press **INPUT** on the remote control or long press the vLauncher background and touch **General** on-screen (if needed) to display the **General Settings** menu.
2. Drag the volume slider directly to adjust the value.
3. Press **Mute** on the remote control to enable or disable the mute function.
4. Press **BACK** on the remote control, or touch a blank area outside of the menu to exit.

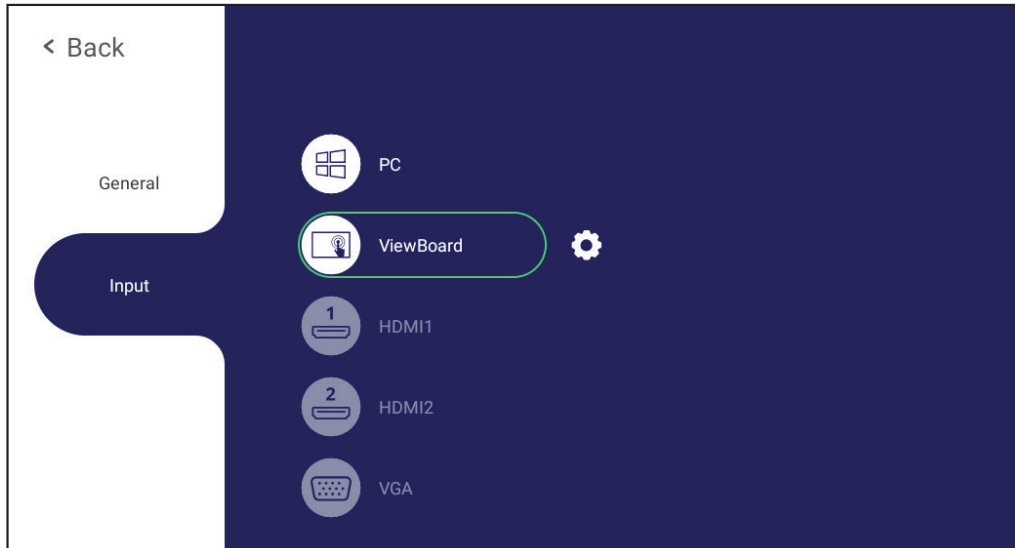
Input Settings



To select an Input Source:

1. Press **INPUT** on the remote control, press the setting button  on the front panel, or press the  setting icon from the toolbar to display the **Input Settings** menu.
2. Press **▼/▲/◀/▶** to select the input source you want.
NOTE: PC source will only display when the slot-in computer is connected.
3. Press **ENTER** on the remote control, or touch the input source.
4. Press **BACK** on the remote control, or touch a blank area outside of the menu to exit.

NOTE: To adjust the settings of an input source, touch the setting icon next to the highlighted input source.

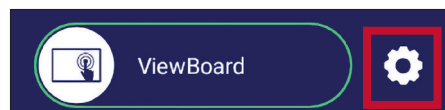

Widget

NOTE: Only available for the Embedded Player source.

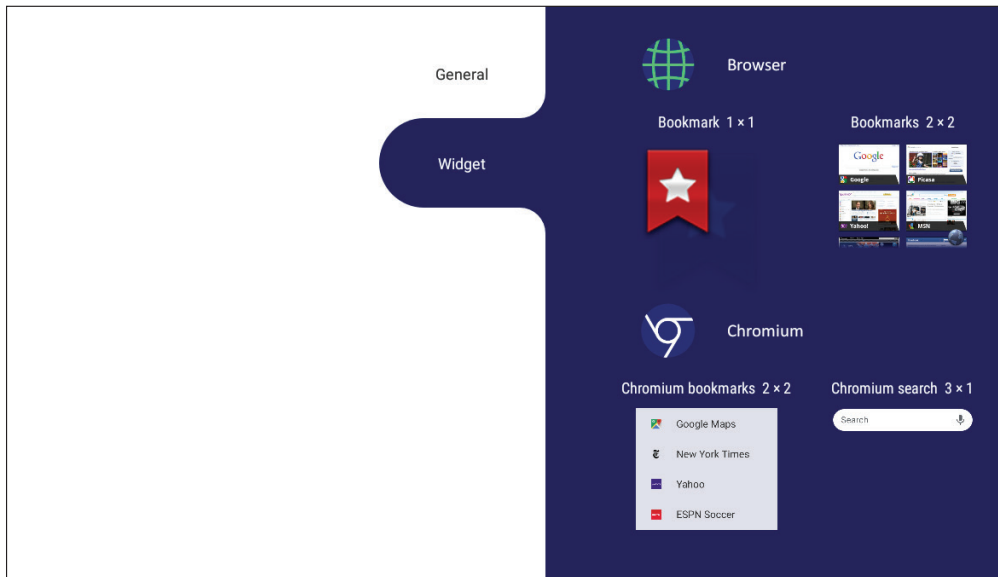

To add a widget to the vLauncher welcome screen:

1. Long press the vLancher background via touch to launch the OSD Menu.



2. Select **Widget**.

3. Touch and hold the desired widget.

4. Drag the widget onto the vLauncher background.

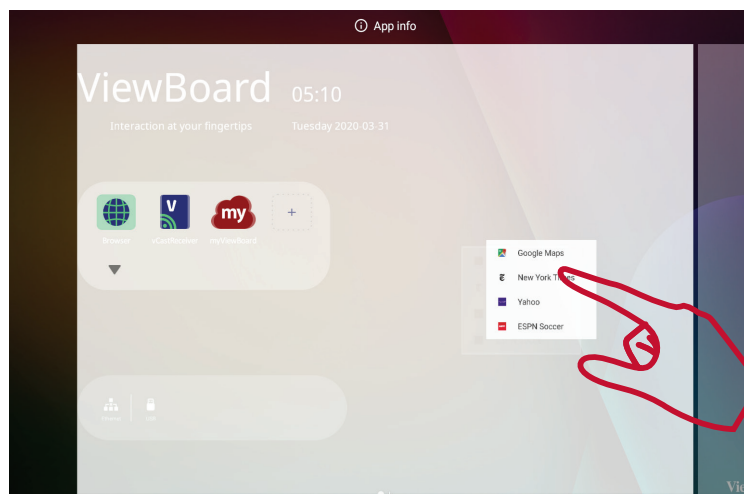

Settings - HDMI & VGA Input Source

Press **MENU** on the remote control or select the setting icon next to the input source in **Input Settings** to launch the **Settings** menu. Settings include: **Audio**, **Screen**, **Display**.

Audio Settings



1. Press **▼** on the remote control and select the **Audio** menu.
2. Press **▼/▲/◀/▶** on the remote control or directly touch the option to select it.
3. Adjust the Volume, Bass, Treble, and Balance directly by touching and adjusting each value, or with the remote control by pressing **ENTER** to adjust the option.
4. Touch the Mute slider directly to enable/disable mute, or press **⏏(Mute)** on the remote control.
5. Press **BACK** on the remote control, or touch a blank area outside of the menu to exit.

Screen Settings

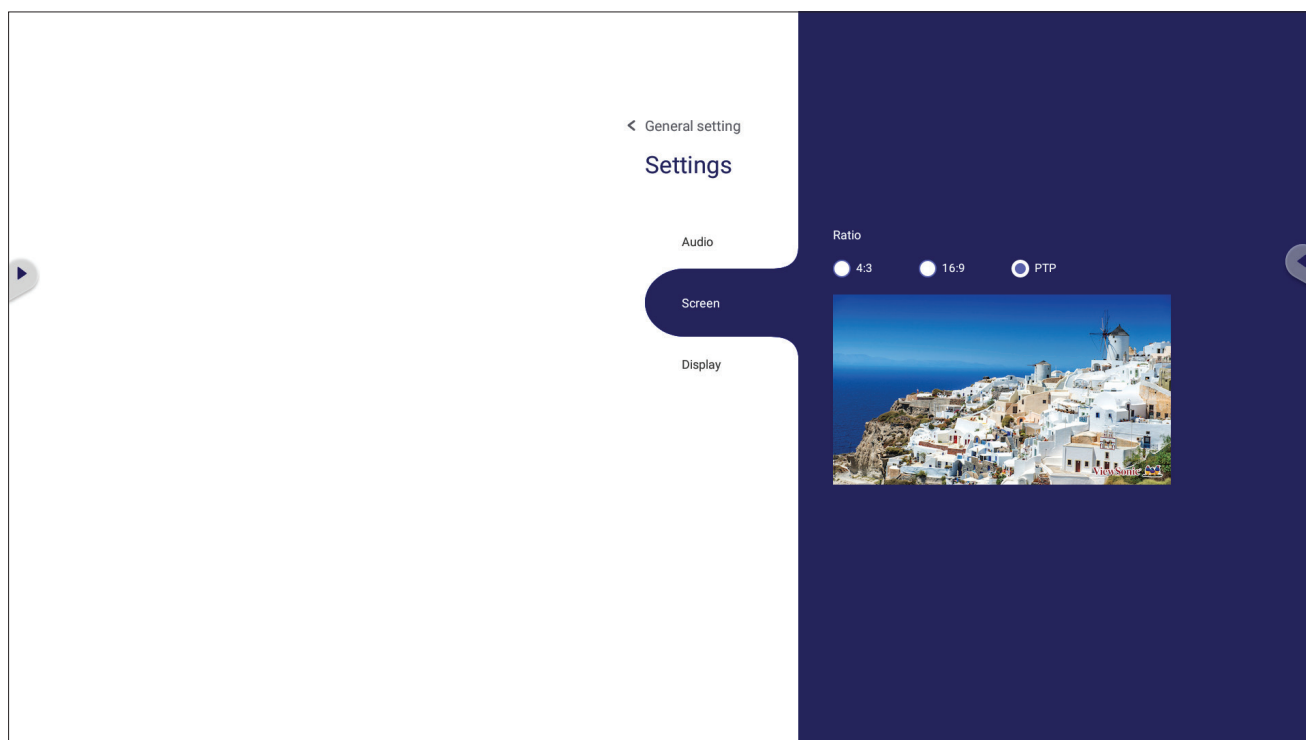

1. Press ▼ on the remote control and select the **Screen** menu.
2. Press ▼/▲/◀/▶ on the remote control or directly touch the option to select it.
3. Adjust your preference by touching each value directly, or with the remote control by pressing **ENTER**.
4. Press **BACK** on the remote control, or touch a blank area outside of the menu to exit.

Display Settings

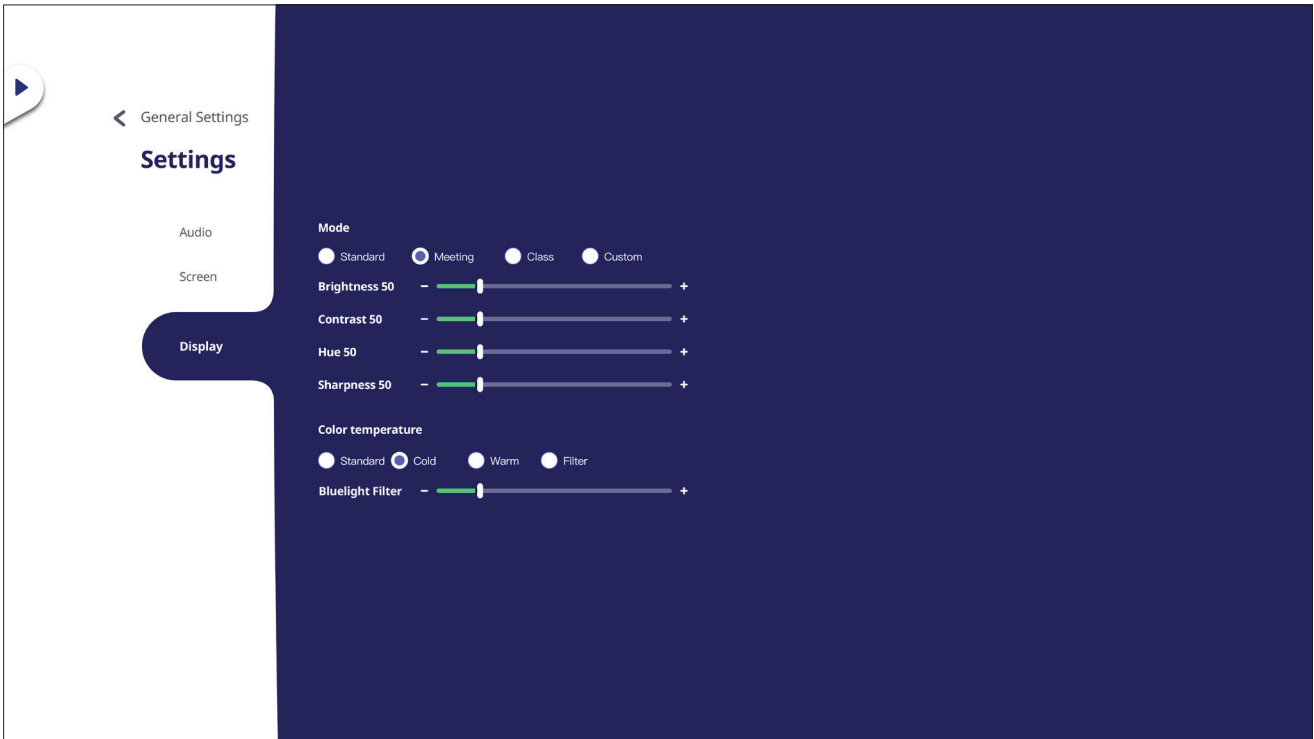

1. Press ▼ on the remote control and select the **Display** menu.
2. Press ▼/▲/◀/▶ on the remote control or directly touch the option to select it.
3. Adjust the Brightness, Contrast, Hue, and Sharpness directly by touching and adjusting each value, or with the remote control by pressing **ENTER** to adjust the option.
4. Drag the blue light slider directly to adjust the blue light value.



5. Press **BACK** on the remote control, or touch a blank area outside of the menu to exit.

Low Blue Light Filter and Eye Health

The Blue Light Filter blocks high-energy blue light for a more comfortable viewing experience.

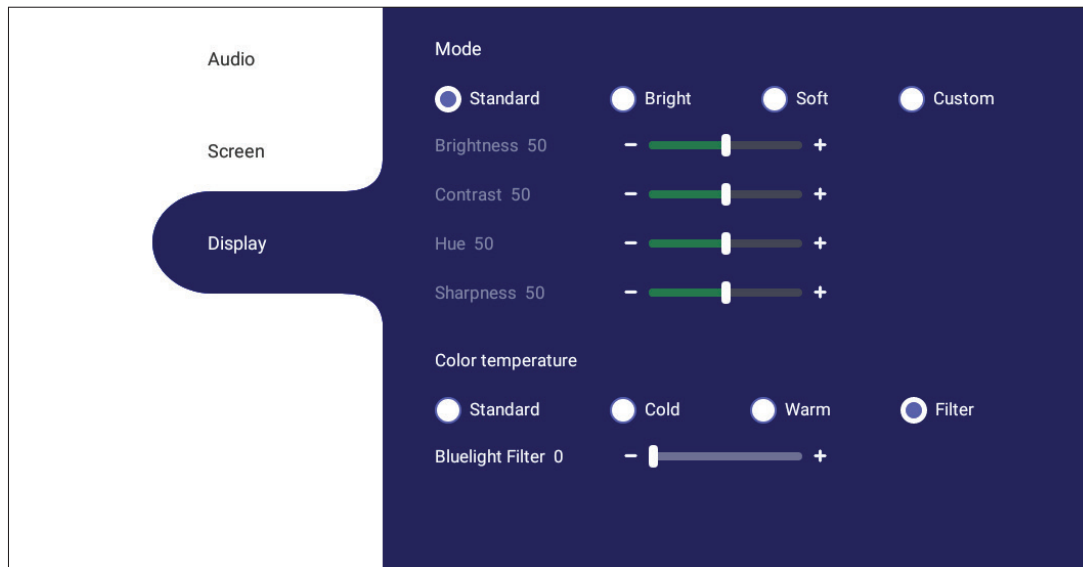

Calculating Breaks

When viewing screens for extended periods, it is recommended to take periodic breaks from viewing. Short breaks of at least 10 minutes are recommended after one (1) hour of continuous viewing.

Taking shorter, more frequent breaks are generally more beneficial than longer, less frequent breaks.

Focus Fatigue (20-20-20 Rule)

To reduce the risk of eye fatigue by constantly looking at the screen, look away from the screen at least every 20 minutes and gaze at a distant object (at least 20 feet away) for at least 20 seconds.

Looking at Distant Objects

While taking breaks, users can further reduce eye strain and dryness by focusing on objects that are further away from them for 10-15 seconds, then gaze at something up close for 10-15 seconds. Repeat this up to 10 times. This exercise reduces the risk of your eyes' focusing ability to "lock up" after prolonged computer work.

Eye and Neck Exercises

Eye Exercises

Eye exercises can help minimize eye strain. Slowly roll your eyes to the left, right, up, and down. Repeat as many times as needed.

Exercises for the eyes

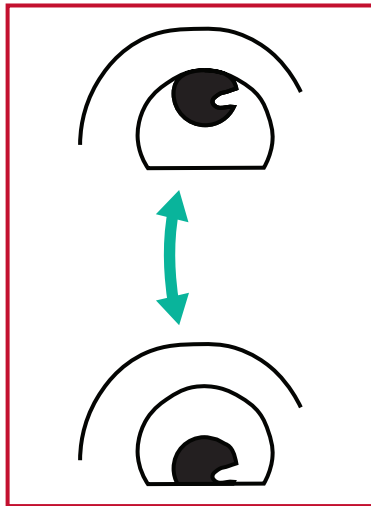

(1) Keep the body and the head upright. Move the eyes up to look at the ceiling, then turn down to look at the floor.

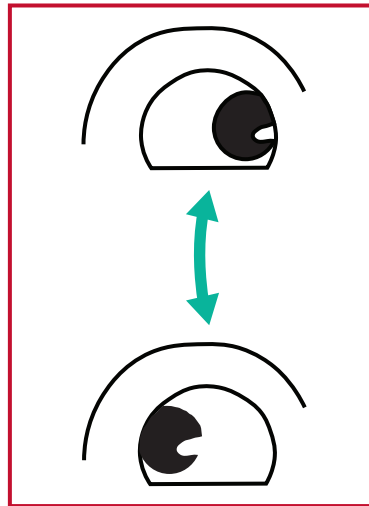

(2) Move the eyes left and right slowly to look at objects on the two sides.

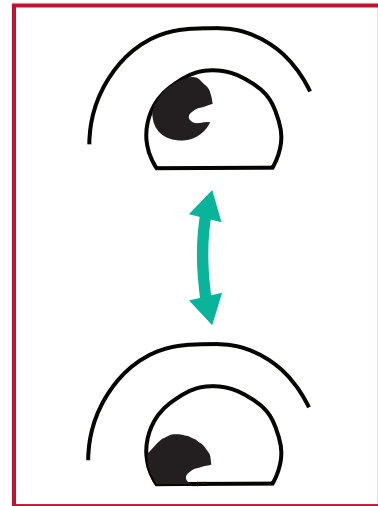

(3) Move the eyes to look at objects at the right upper direction and then right lower direction. Repeat for the left upper and left lower directions.

Neck Exercises

Neck exercises can also help minimize eye strain. Relax your arms and let them hang at your sides, bend forward slightly to stretch the neck, turn your head to the right and to the left. Repeat as many times as needed.

Settings - Embedded Player

When the ViewBoard is in the Embedded Player input source, press **MENU** on the remote control or tap the setting icon next to the input source in the On-Screen Display (OSD) Menu's Input Settings to enter the **Settings** menu.

Wireless & Network

Check current network connection status, set up and manage Wi-Fi, Ethernet, Bluetooth, and VPN, and establish a Wireless hotspot.

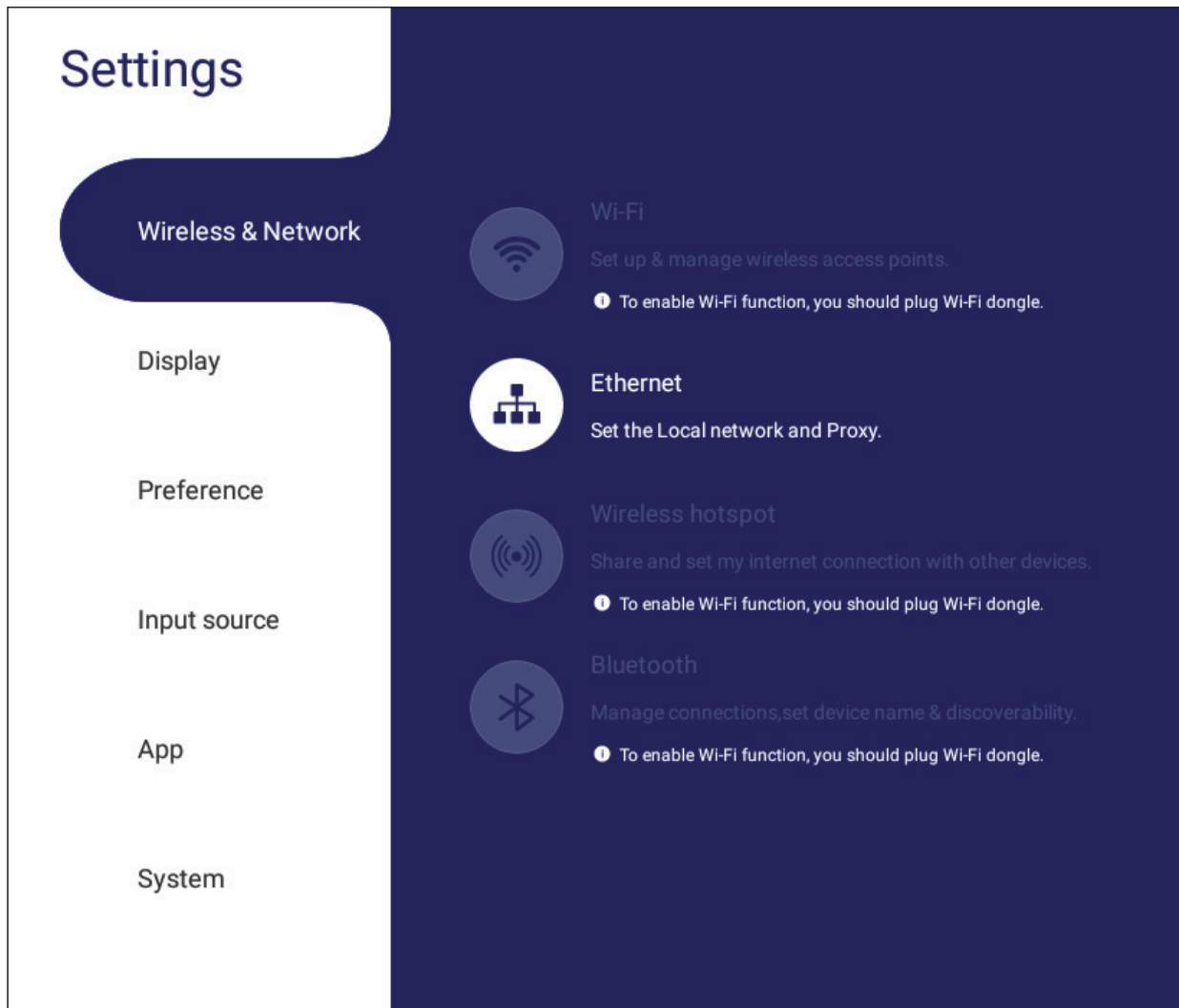

NOTE:

- Wi-Fi, Wireless hotspot and Bluetooth settings will appear when LB-WIFI-001(optional) has been installed.
- Ethernet will disable automatically when Wi-Fi is enabled. Wi-Fi will disable automatically when Ethernet is enabled. Wi-Fi will disable when Wireless hotspot is enabled.
- The device cannot connect to the Internet when Wireless hotspot is enabled.

Wi-Fi

Setup and manage wireless access points.

- Tap the toggle button to turn Wi-Fi **On** or **Off**.

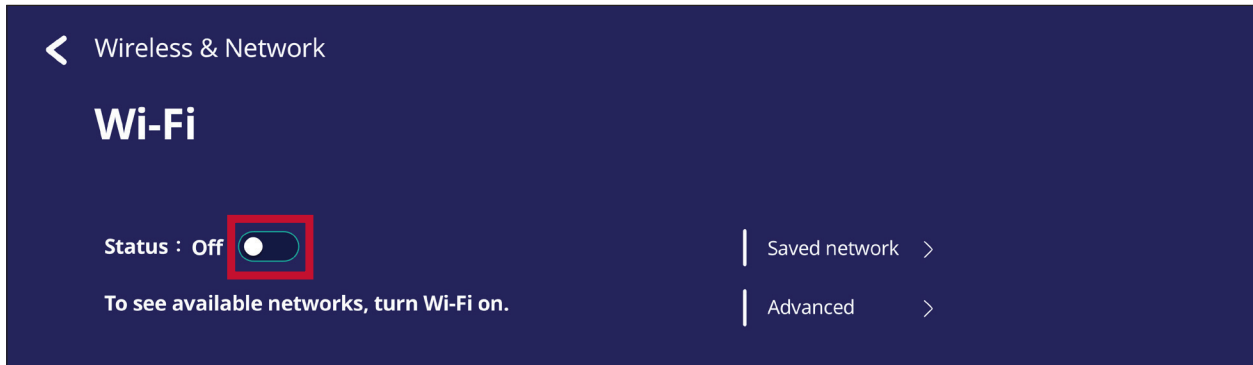

- Once **On**, you can: **Add a Network**, view **Saved Networks**, **Refresh** the network list, or view **Advanced** settings.

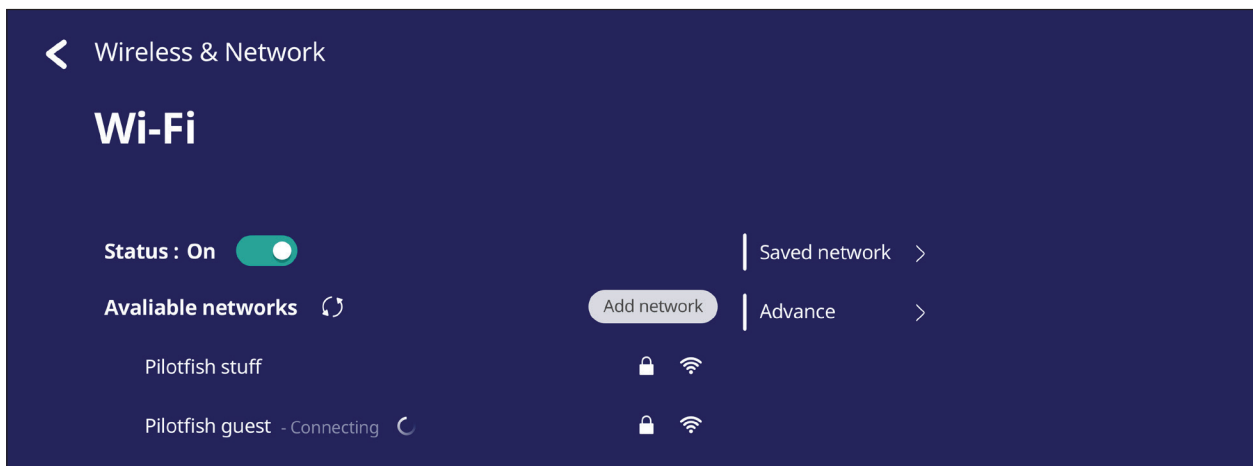

- In **Advanced** settings, you can toggle **Network notifications On** or **Off** and view **Network card info**.

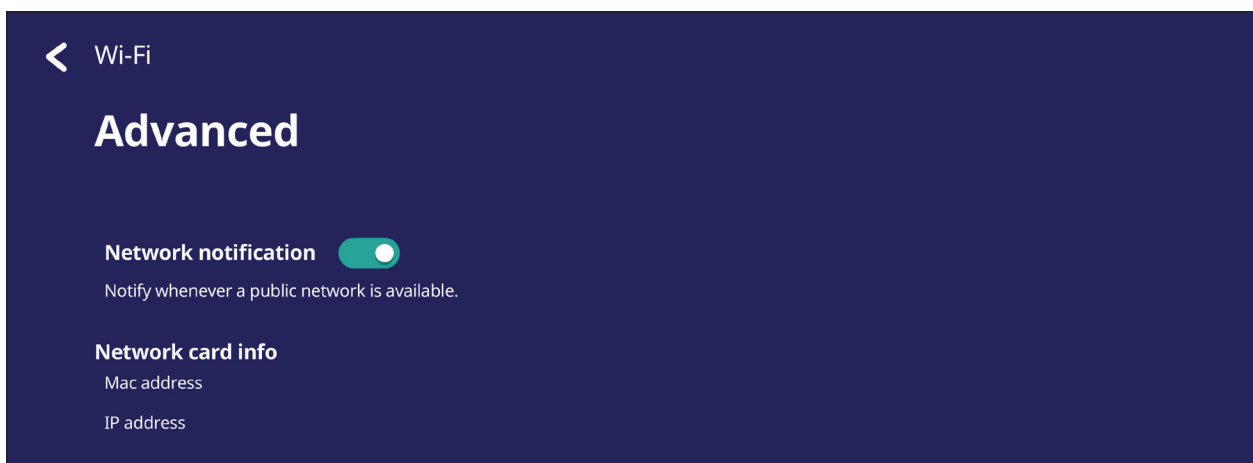

Ethernet

Set the local network and proxy.

- Tap the drop down menu to connect/disconnect the Ethernet.

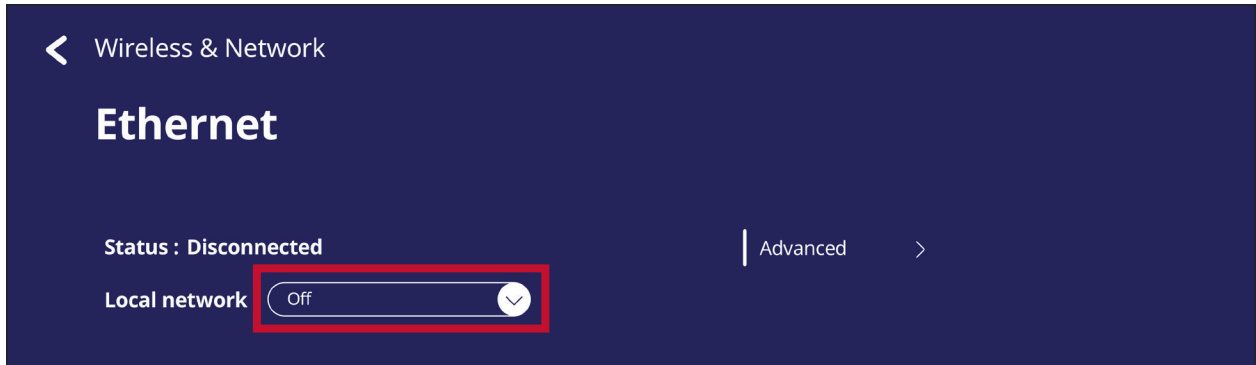

- You can adjust **Local network** and **Proxy** settings as well.

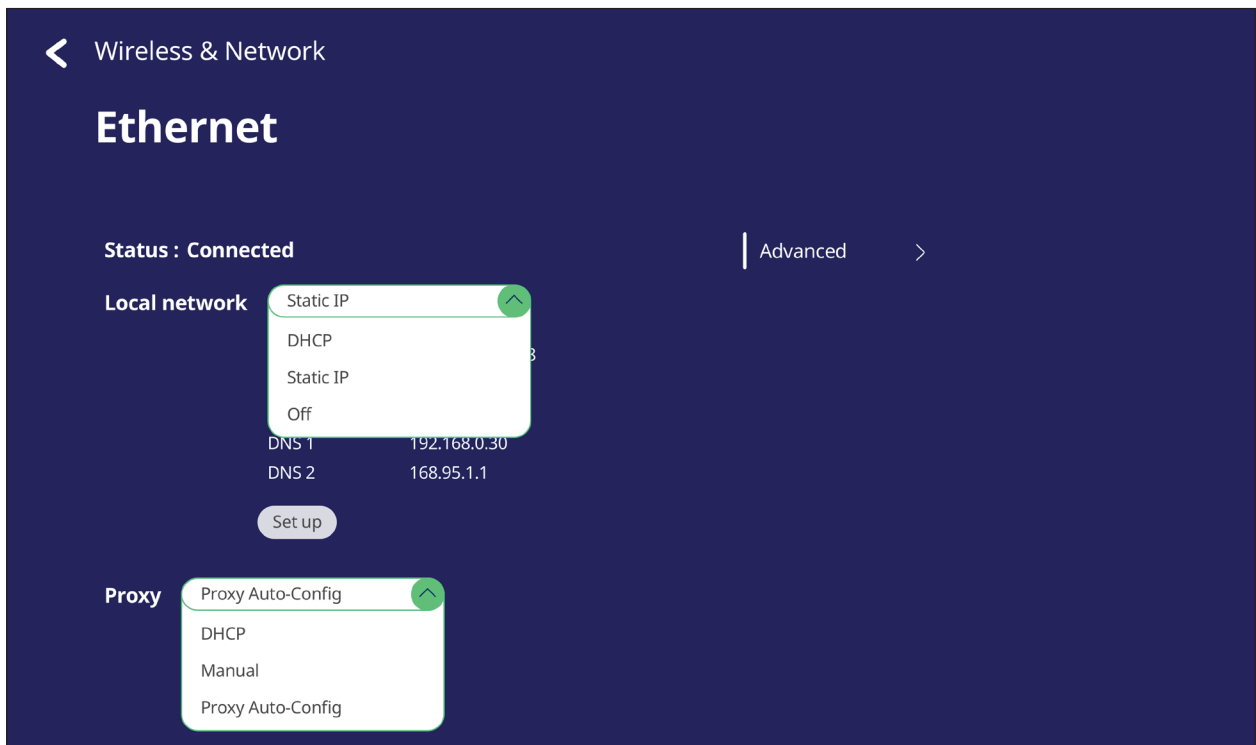

- Tap **Advanced** to view **Network card info** and toggle **Network auto reconnect**.

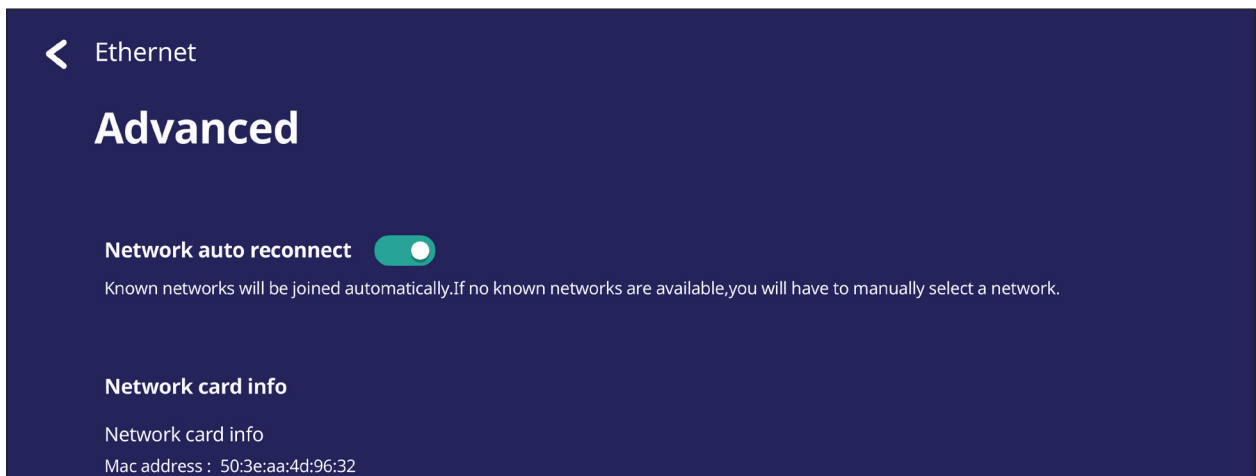

Wireless Hotspot

Set and share my internet connection with other devices.

- Tap the toggle button to turn **Wireless hotspot On** or **Off**.

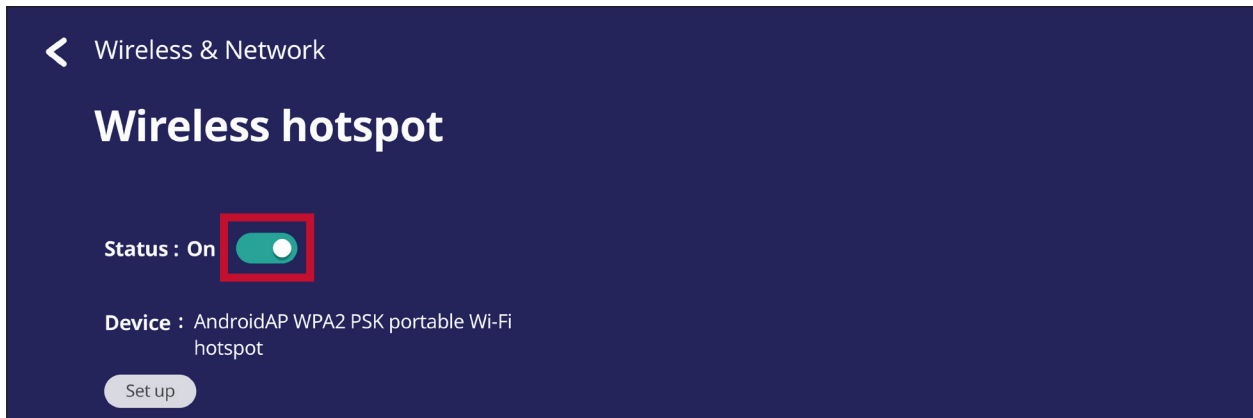

- Tap **Set up** to set the **Network name**, **Security**, and **Password**.

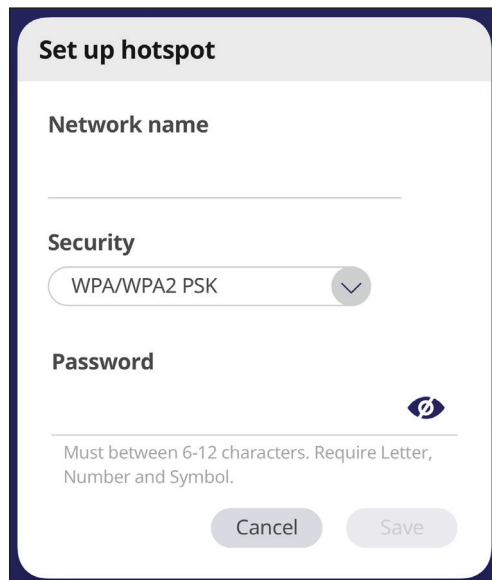

VPN

Setup and manage Virtual Private Networks.

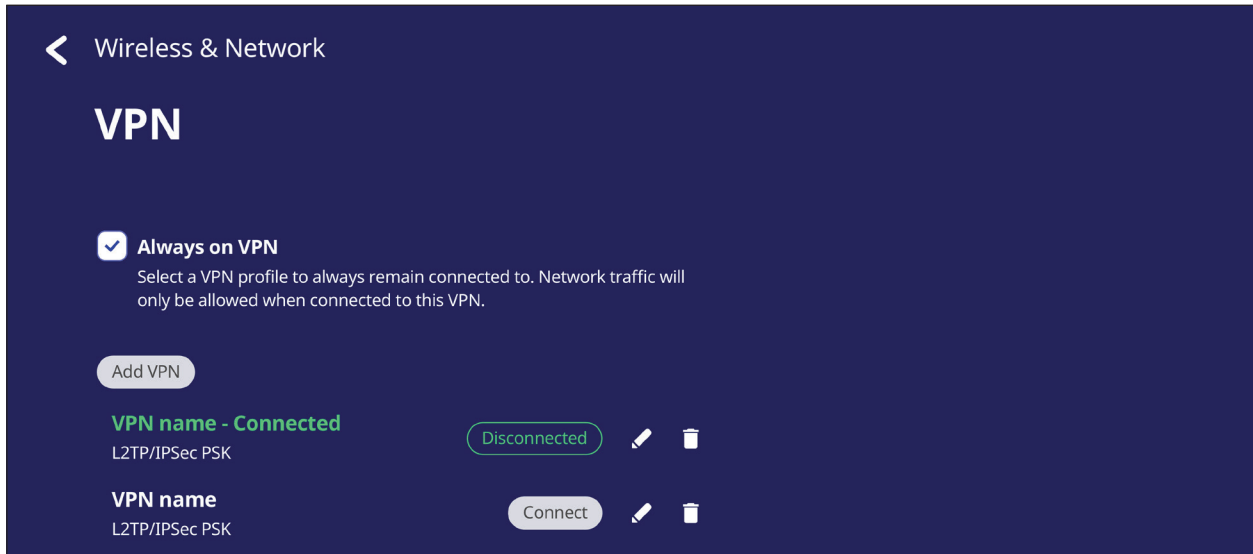

To create a VPN profile:

1. Go to: **Settings > Wireless & Network > VPN** and tap **Add VPN**.

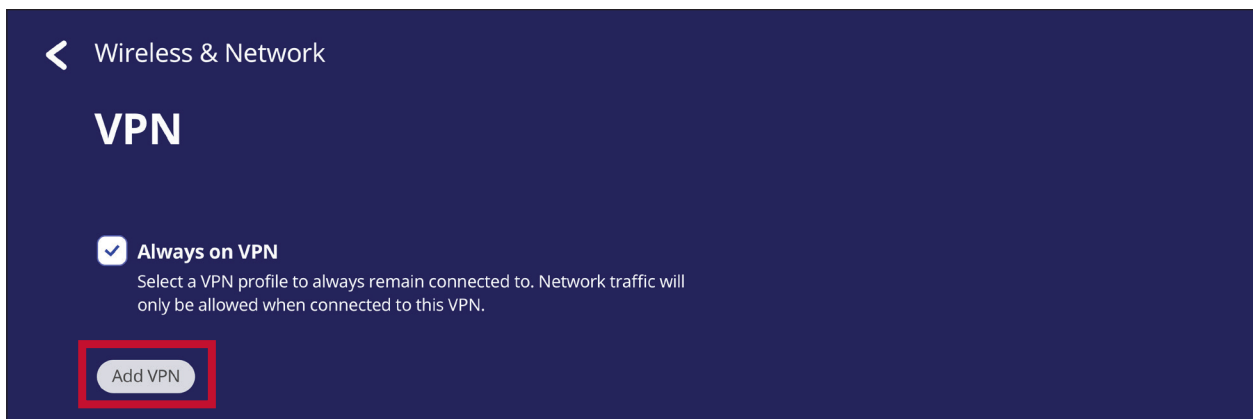

2. Key in the **Name**.

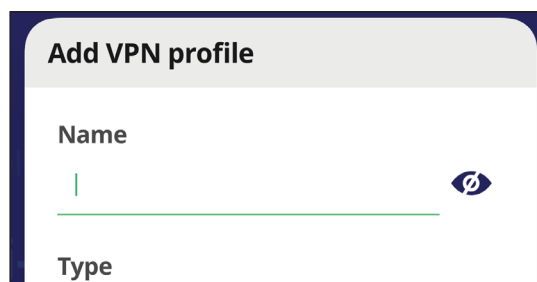

3. Select the VPN Type.

Add VPN profile

Name

Type

- PPTP
- L2TP/IPSec PSK
- L2TP/IPSec PSA
- IPSec Xauth PSK
- IPSec Xauth RSA
- IPSec Hybrid PSK

Cancel save

4. Choose to enable/disable **PPP encryption (MPPE)** and/or show **Advanced options**.

Server address

PPP encryption(MPPE)

Advanced options ^

DNS search domains

DNS servers

0.0.0.0

Forwarding routes

0.0.0.0/0

Cancel Save

Share

SAMBA

The SAMBA Service provides file sharing via LAN. When the SAMBA Service is enabled, the user can explore the ViewBoard file system with a PC or mobile equipment.

1. To access, go to: **Settings > Share > SAMBA.**

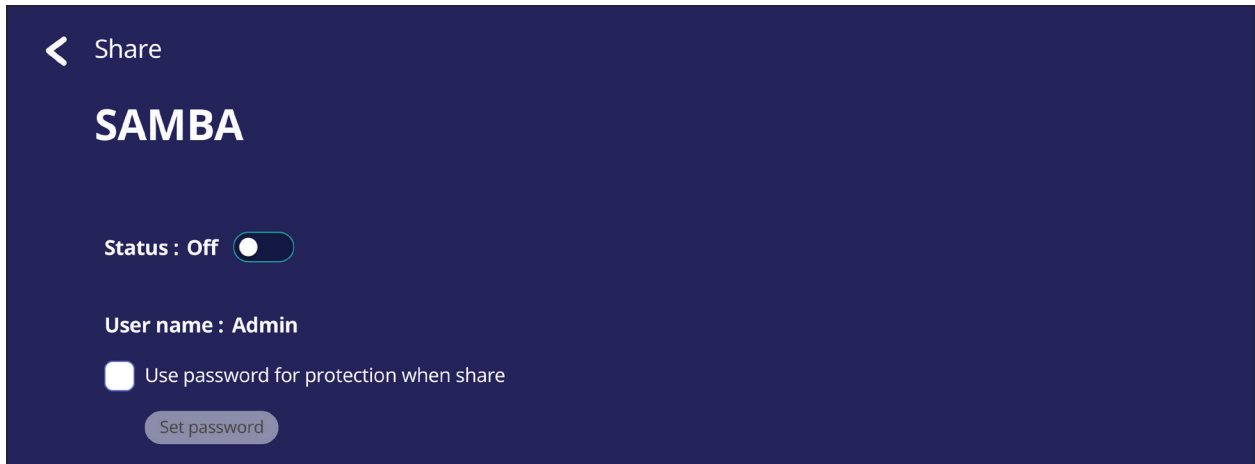

2. Tap the toggle button to enable the SAMBA Service, then set a password if needed.

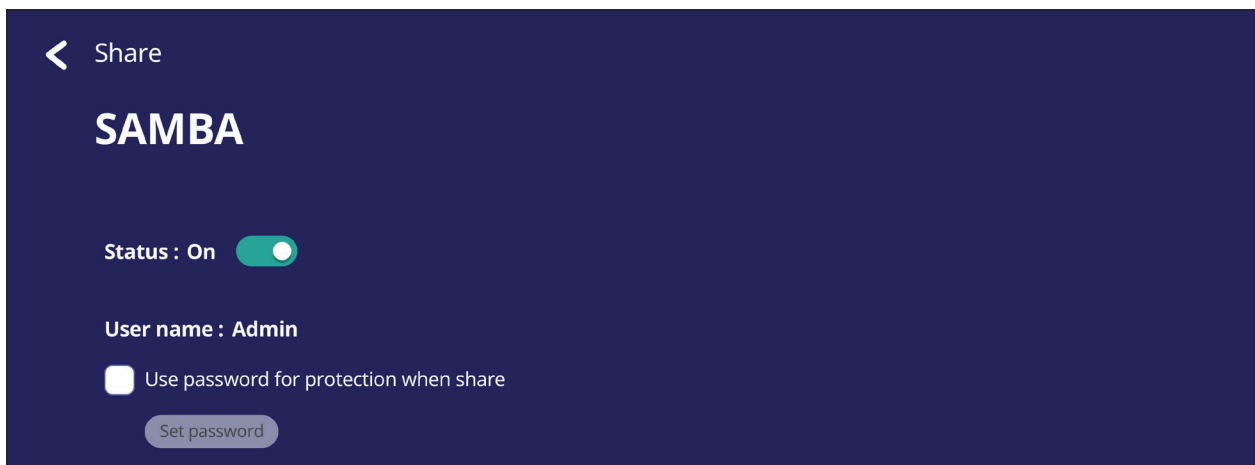

3. Ensure the ViewBoard and client equipment are connected to the same network.
4. Log in to the ViewBoard with the client equipment. Input the ViewBoard's IP address.

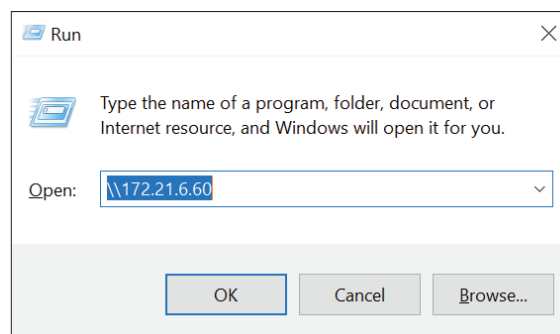

5. Key in the user name and password, then select **OK** (if necessary).

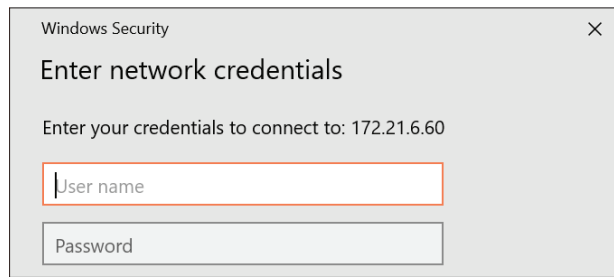

6. After a successful log in, the ViewBoard files will be available.

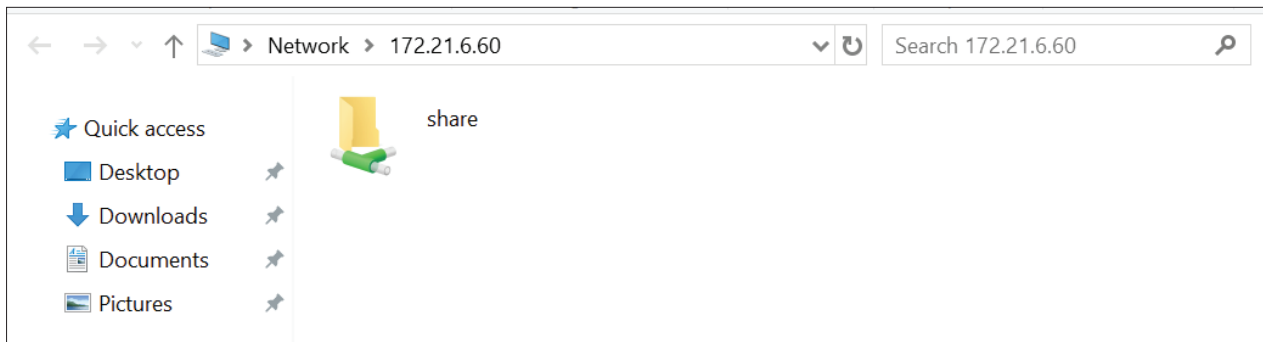

Display

Adjust the Wallpaper, Theme, Display ID, and Protection settings.

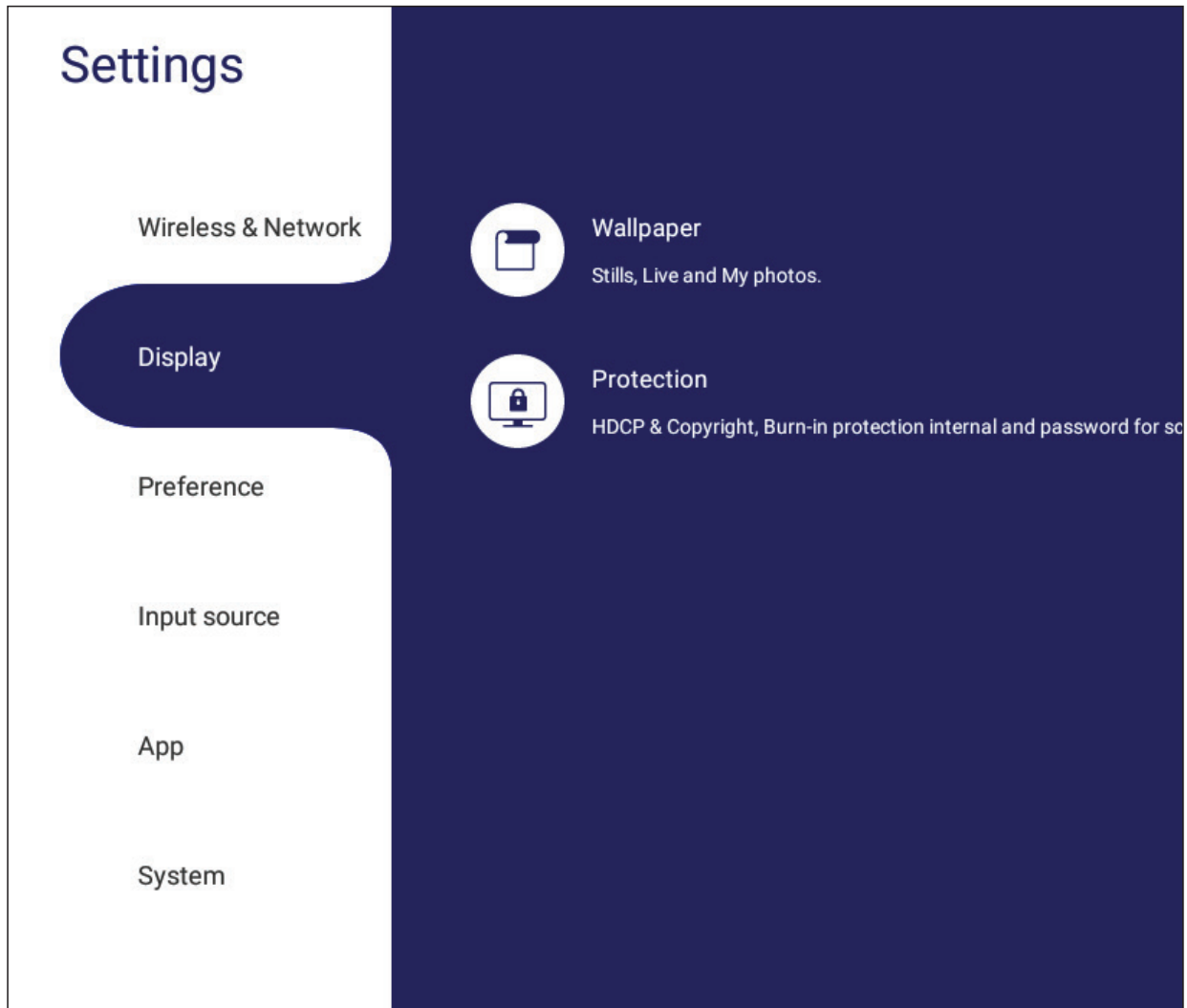

Wallpaper

Users can change their wallpaper with default images (both still and live), or

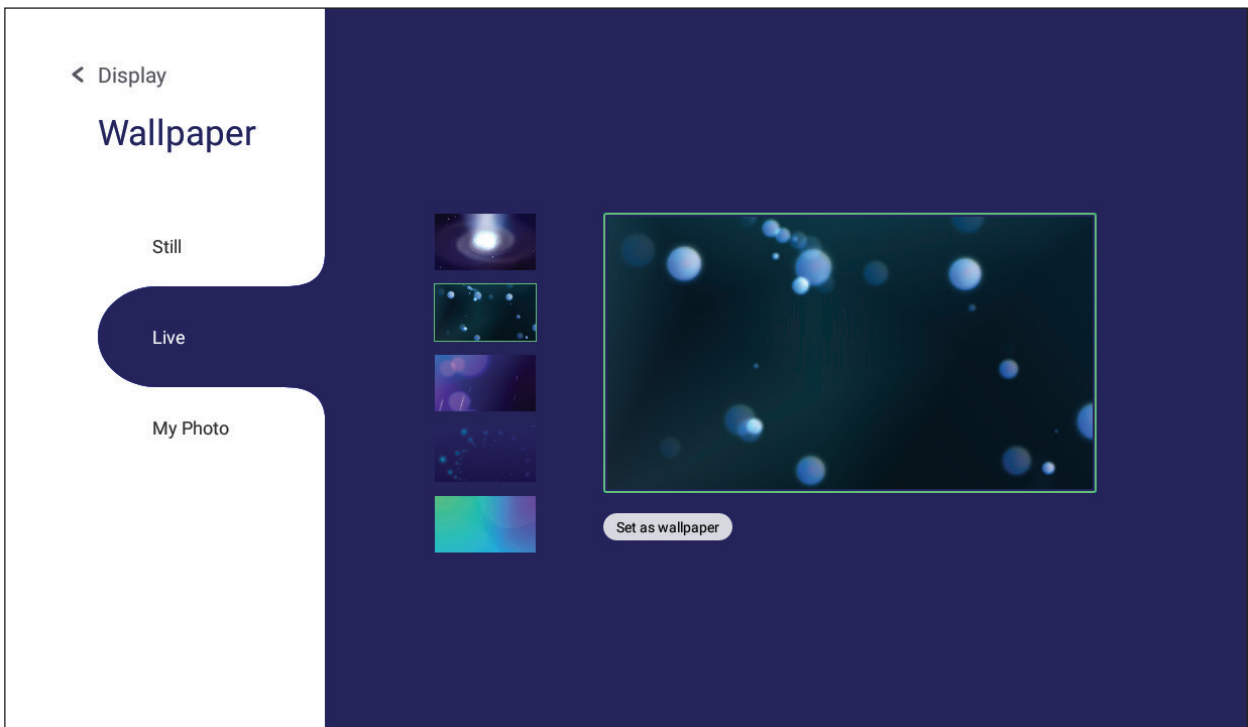

use their own by tapping **My Photo** and selecting the image file.

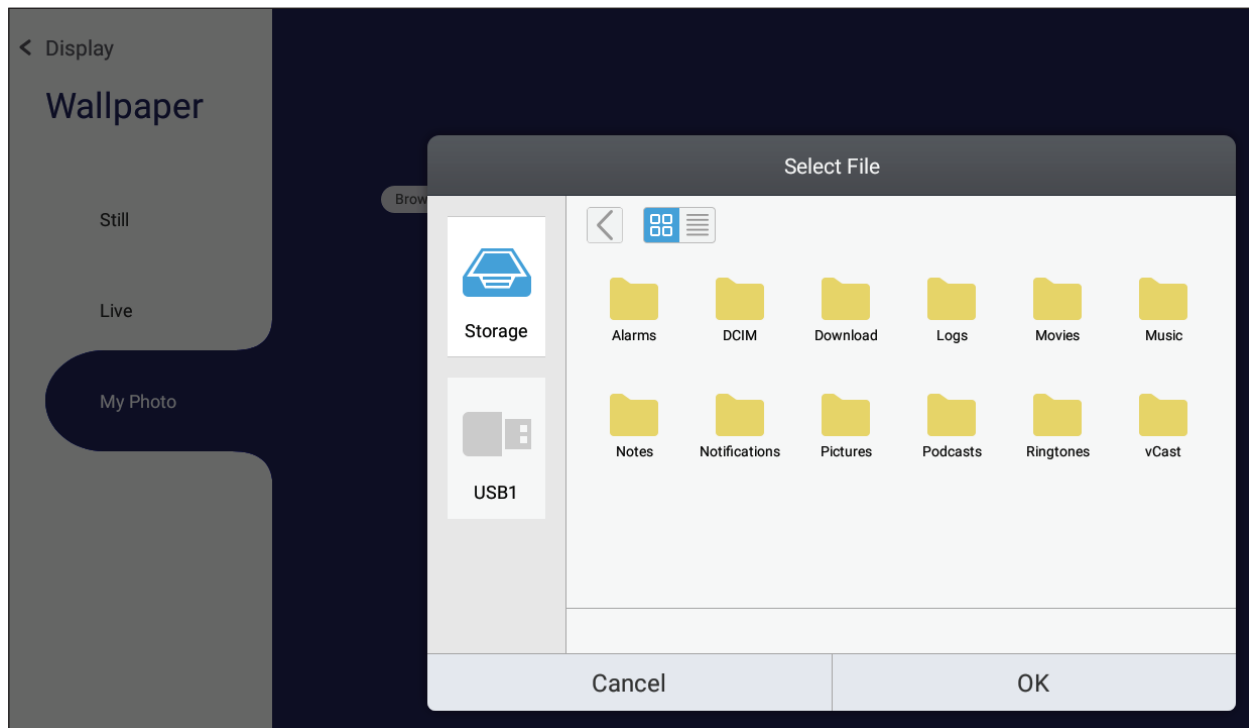

Protection

Set a **Password for Screen Lock**.

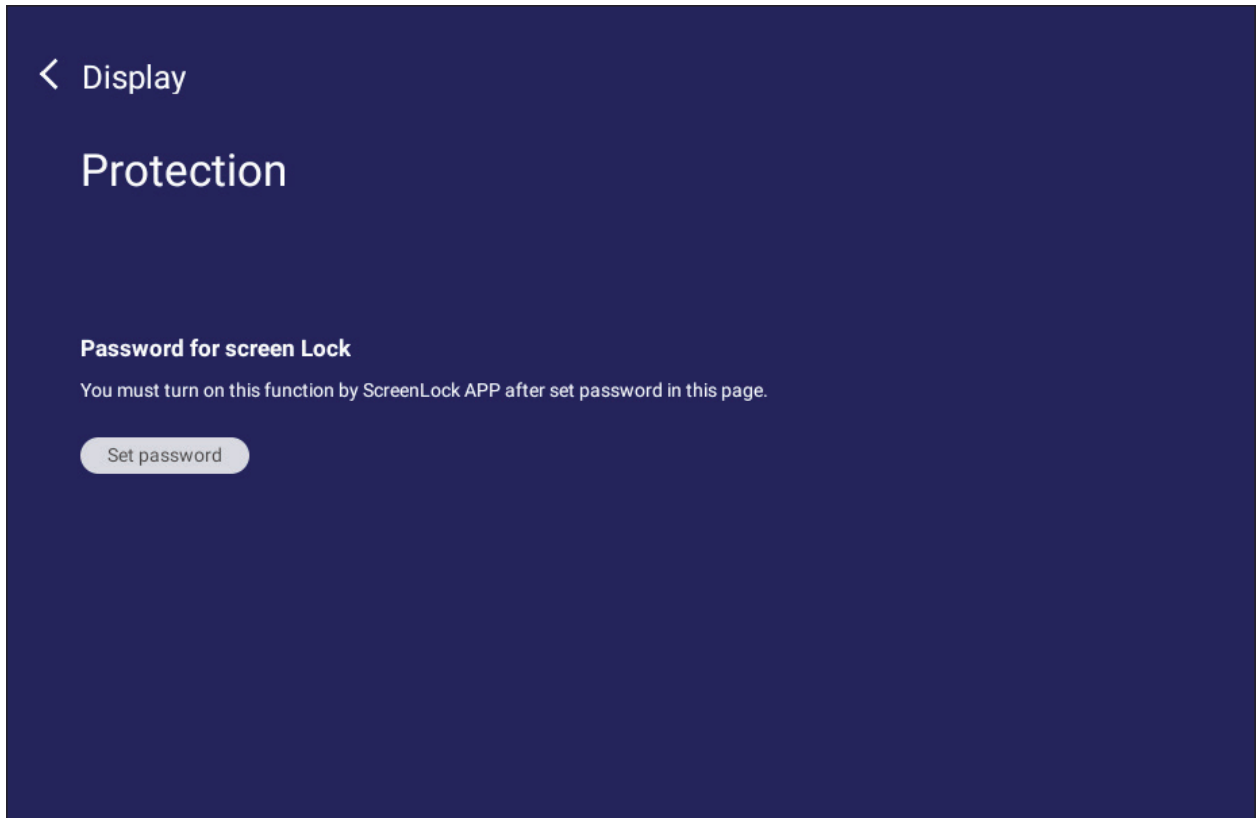

- To set up a password for screen lock, tap **Set Password** and enter the desired password.

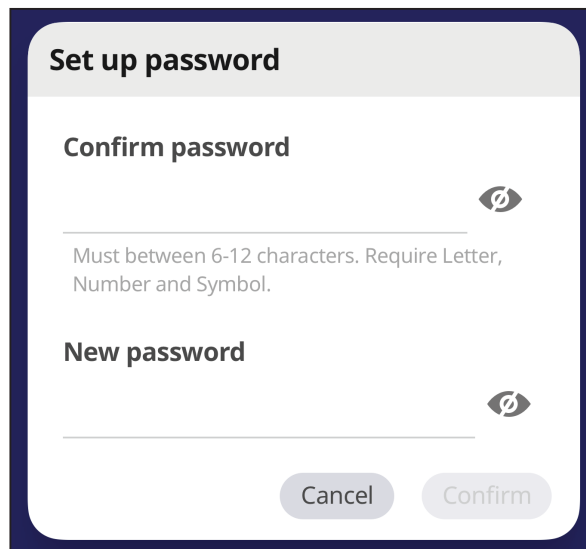

Preference

View and adjust **Touch, Language, Keyboard & Input, Date & Time, Boot, and Start up & Shut down** settings.



Touch

Adjust **Touch Settings** and toggle **Touch Sounds** and **Windows Ink On/Off**.



Language

Adjust and choose the preferred language from the available languages.

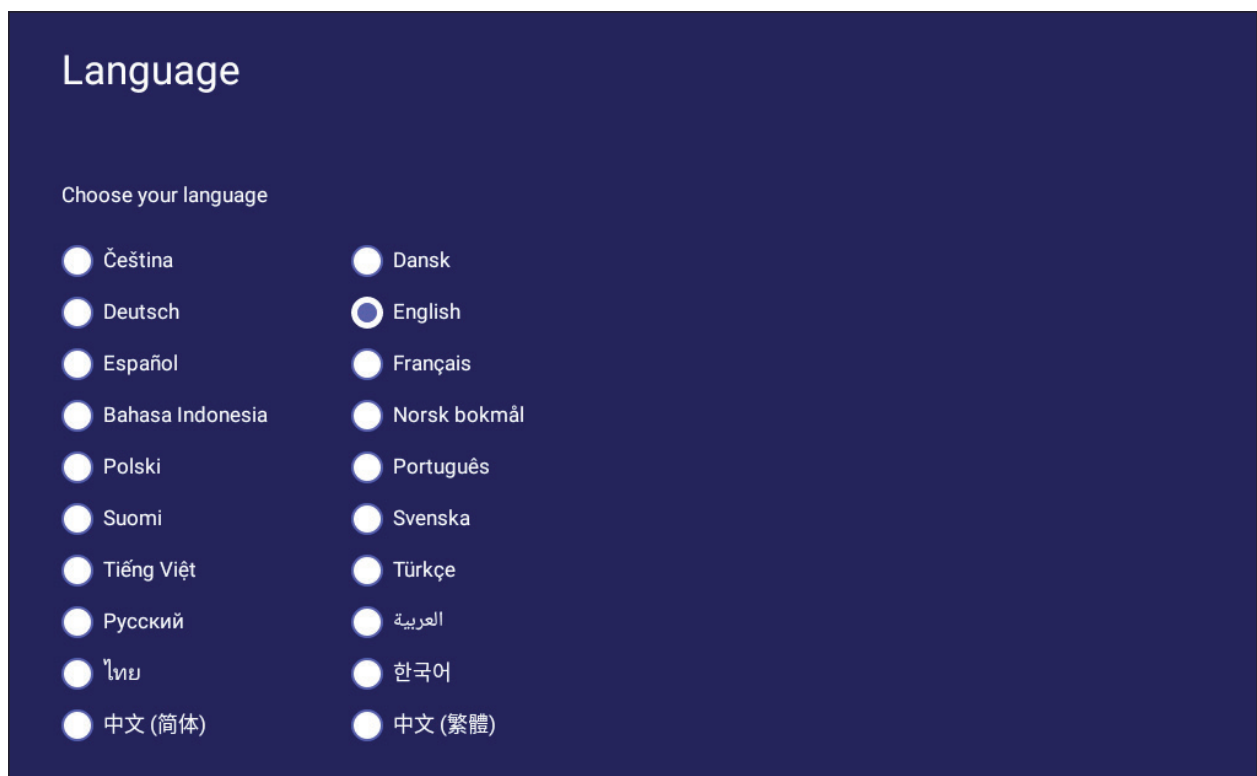

Keyboard & Input Method

Enable/disable the visual keyboard and/or change the default input method.



- Tap on **Settings** to adjust the advanced keyboard settings.

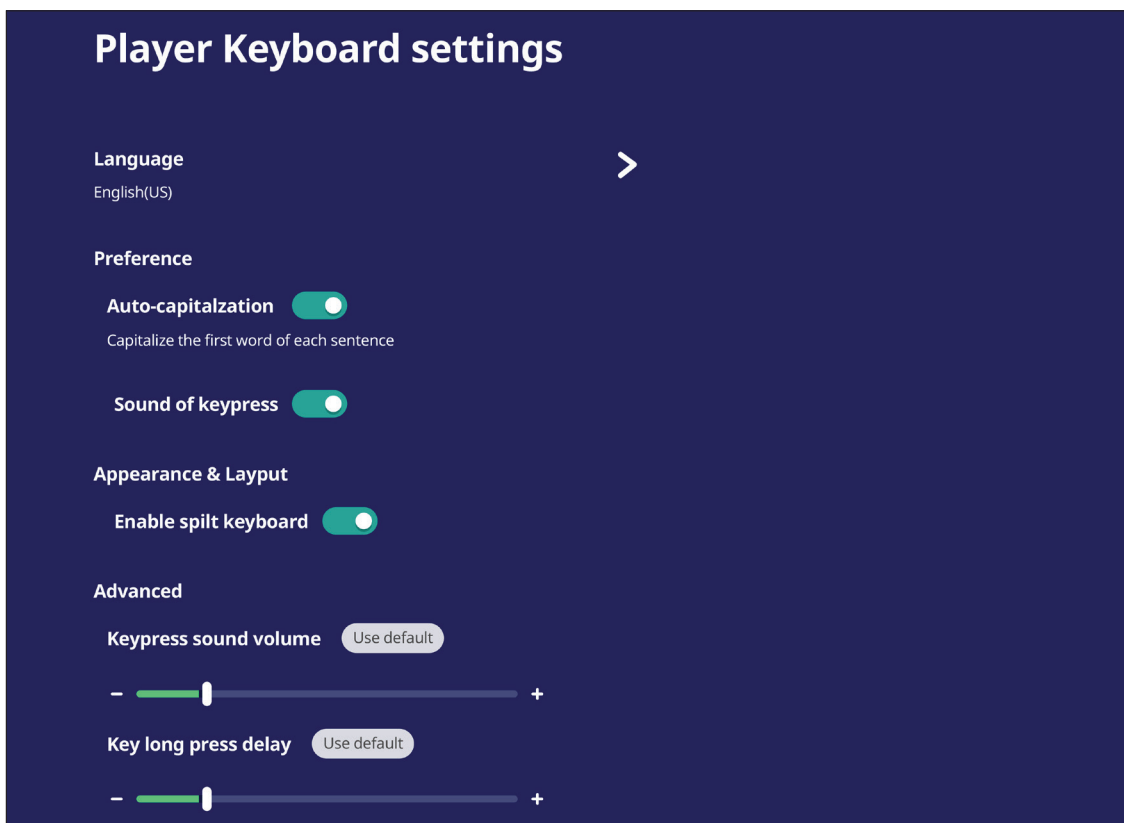
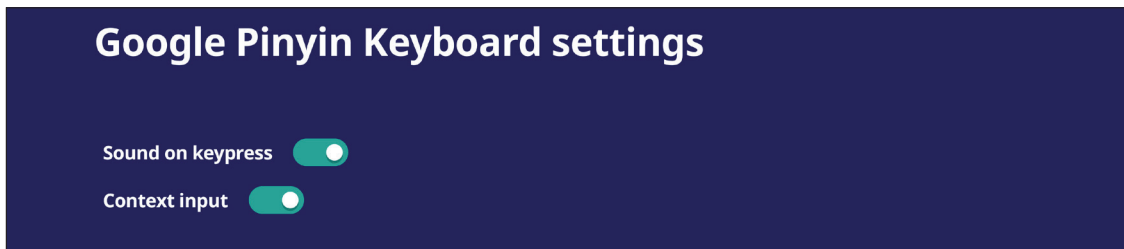

Date & Time

Set the system time and format.

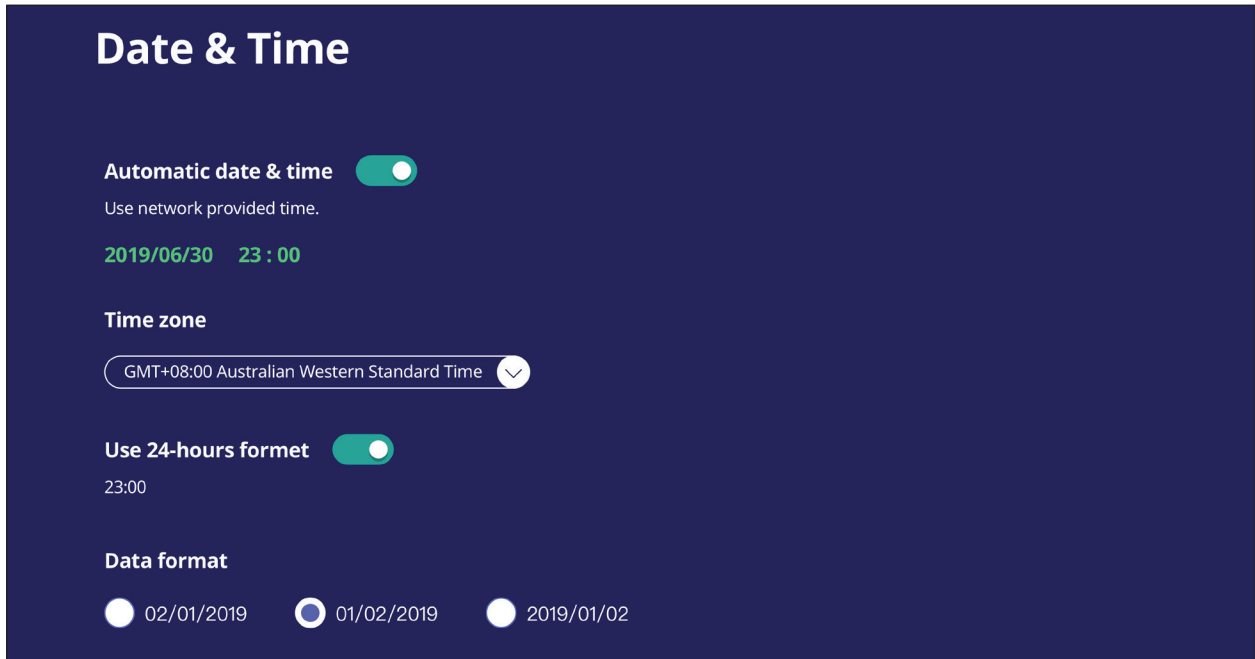

Item	Description
Automatic Date & Time	When enabled, the ViewBoard will automatically synchronize the date and time via the Internet.
Time Zone	Select the appropriate time zone.
Time Format	Choose from 12-hour or 24-hour time format. Simply toggle 24-hour format On/Off.
Date Format	Select from the available date formats.

Boot Mode

Adjust the preferred boot up mode and set/reset a password.

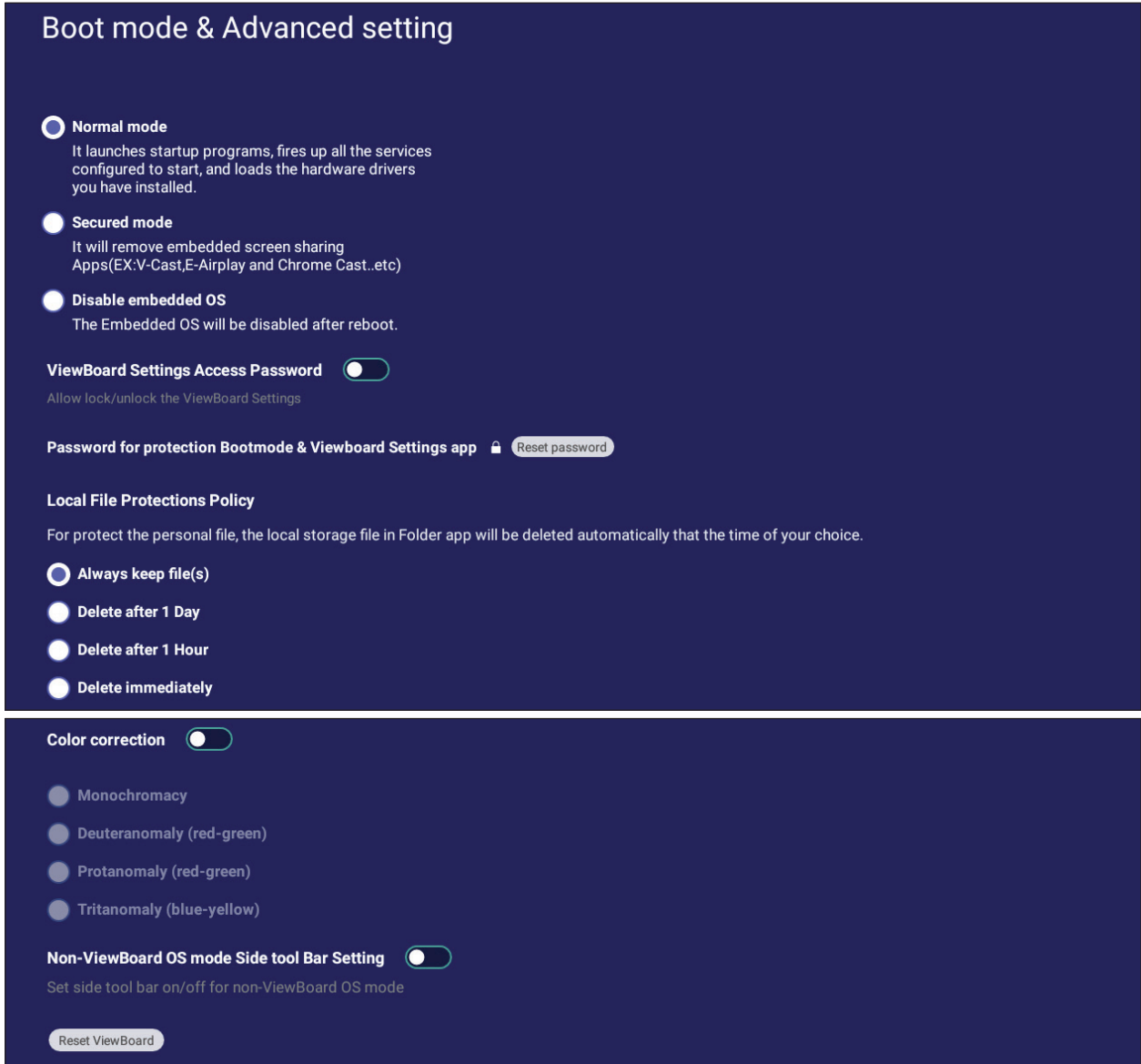

Item	Description
Normal Mode	The embedded screen sharing Apps will run normally.
Secured Mode	The embedded screen sharing Apps will be removed.
Disable Embedded OS	The system will automatically reboot, and then the Embedded OS will not appear.
ViewBoard Settings Access Password	Toggle to lock/unlock the ViewBoard Settings.
Password for Protection	Modify the Boot mode and ViewBoard Settings entry password.
Local File Protection Policy	Choose how long to keep local storage files in the Folder app.
Color Correction	Color correct the ViewBoard display screen.
Non-ViewBoard OS Mode Side Toolbar Setting	Enable the side toolbar for non-ViewBoard OS.
Reset ViewBoard	Rest the ViewBoard to its factory default settings.

Startup & Shutdown

Set the **Startup Input**, **Standby Mode**, **EnergyStar Mode**, **Black Screen After Startup**, **Power off Reminder** timer and **Schedule** settings.

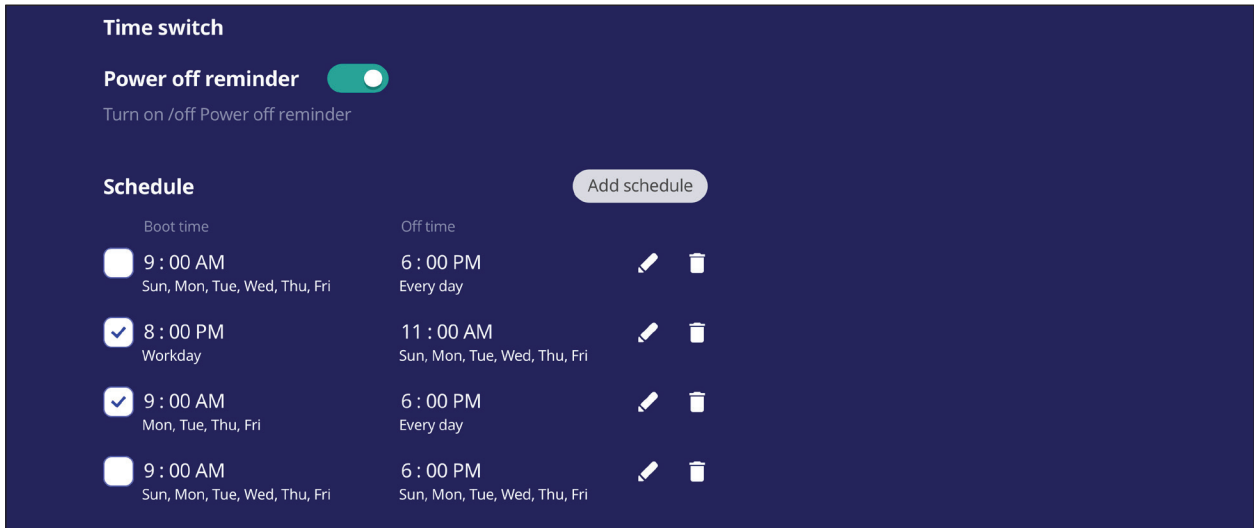
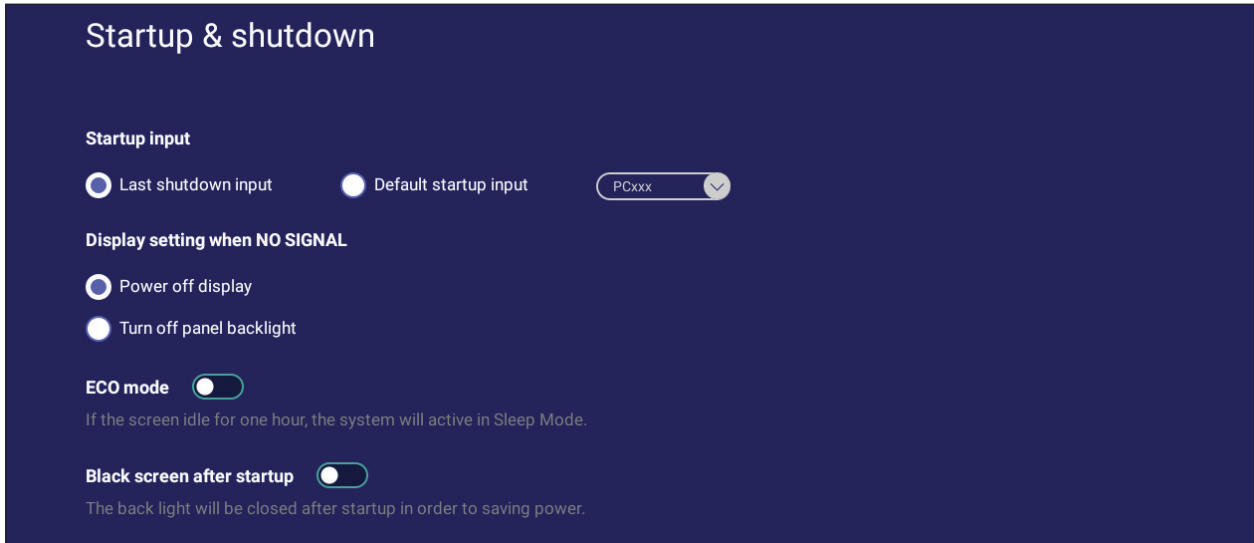

Item	Description
Startup Input	Adjust the Startup Input preference.
Display Setting when No Signal	Decide what happens to the display when there is no signal for HDMI, PC, or VGA sources.
ECO Mode	Enable to automatically initiate <i>ECO Mode</i> when the screen is idle for one hour.
Black Screen After Startup	When enabled, the ViewBoard will turn off the backlight automatically after booting up.
Time Switch Power Off Reminder	When enabled, the ViewBoard will turn off without any reminder after the scheduled off time.
Schedule	Schedule a Boot and Shut off time.

Toolbar Setting

Adjust the Side toolbar settings.

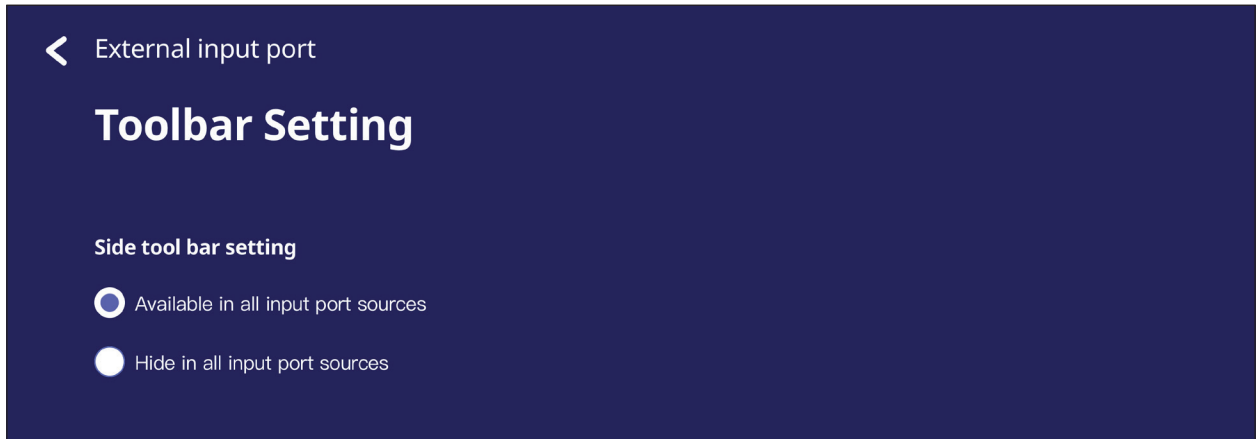

Input Source

Adjust the input source names and settings, as well as the side tool bar settings.

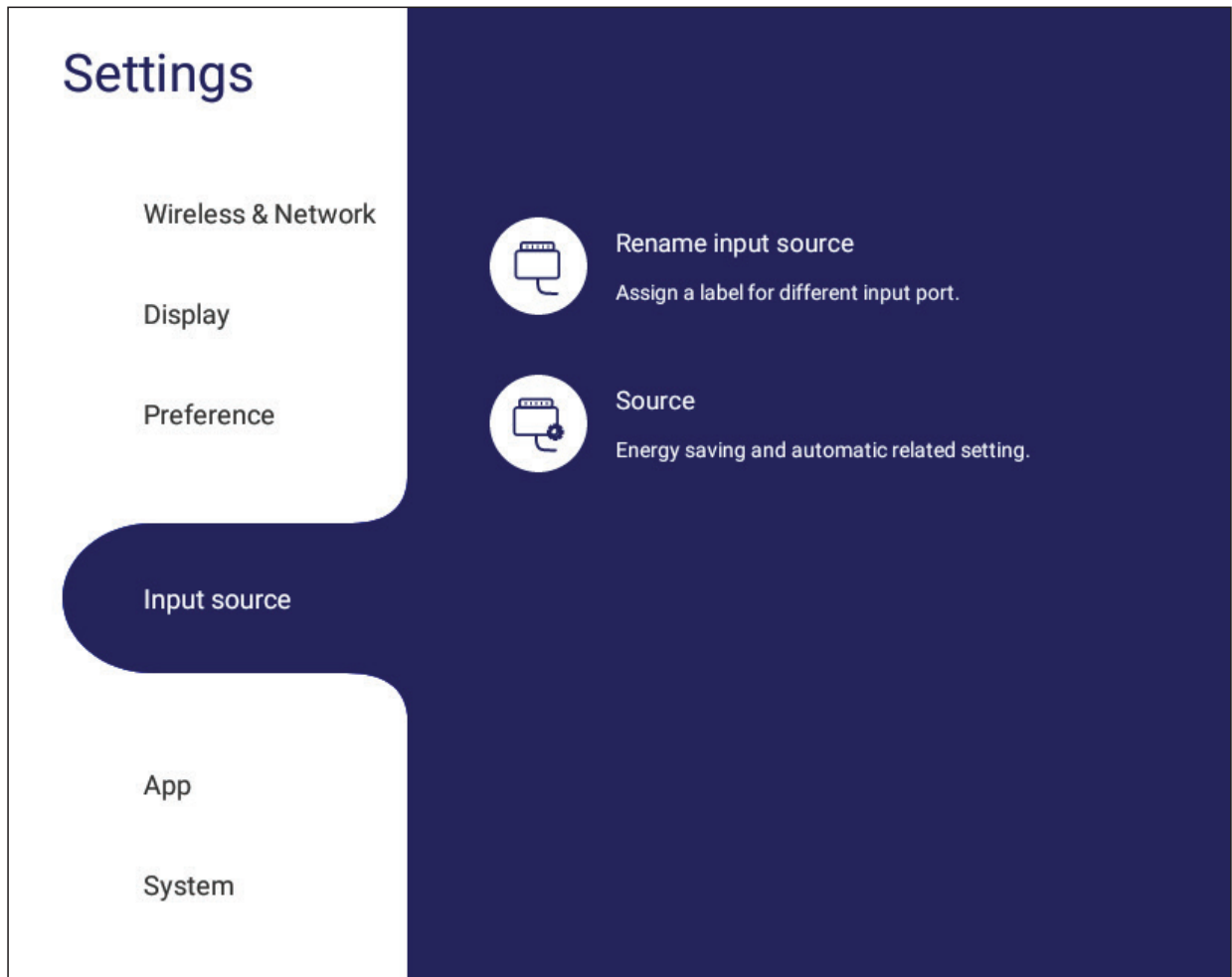

Rename Input Source

Set labels for each input source that will be easily recognized when displayed.

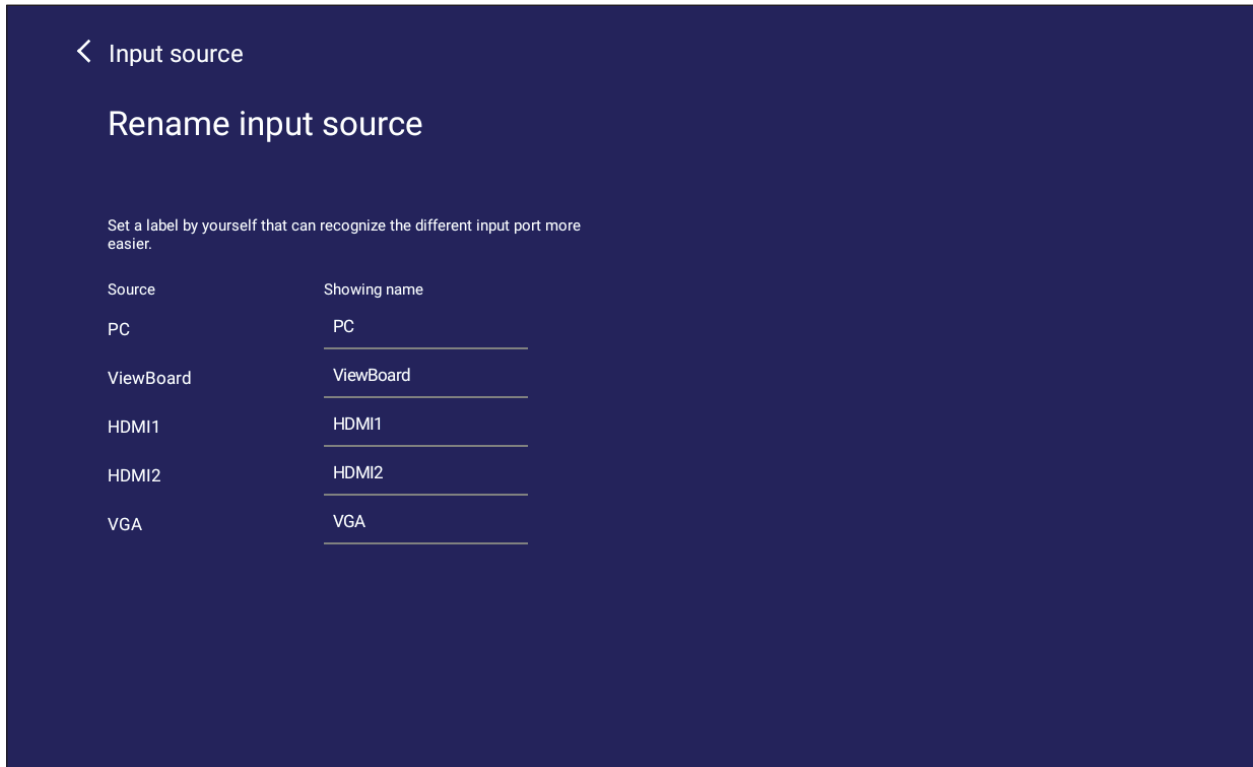

Source

Toggle Wake up by active source, Signal auto search, and HDMI CEC and select Input port auto switch.

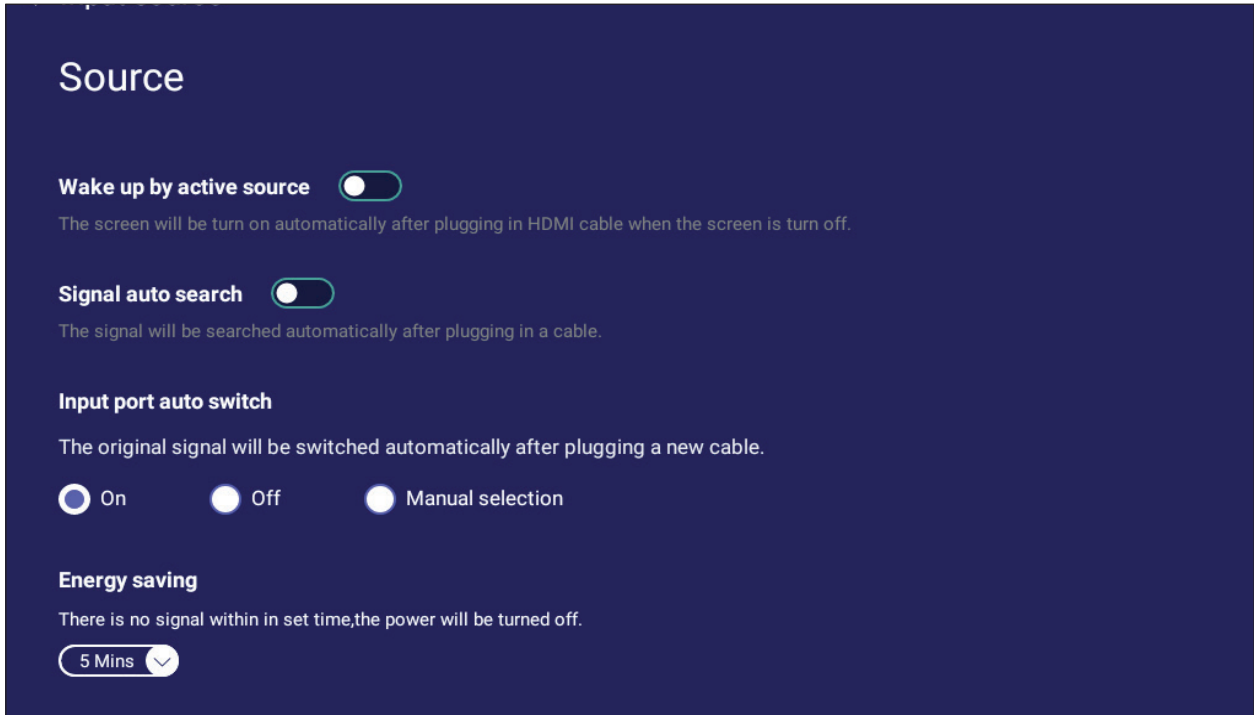

Item	Description
Wake up by Active Source	The screen will turn on automatically after plugging in an HDMI cable when the screen is off.
Signal Auto Search	When enabled, if the current source does not have a signal, the ViewBoard will automatically search for an input source.
Input Port Auto Switch	The original signal will automatically switch to a new cable after it's plugged in.
Energy Saving	Set a time period to power off if no signal is detected.

App

The user can view App information and force stop, uninstall, move to USB storage, clear data, clear cache, and clear defaults.

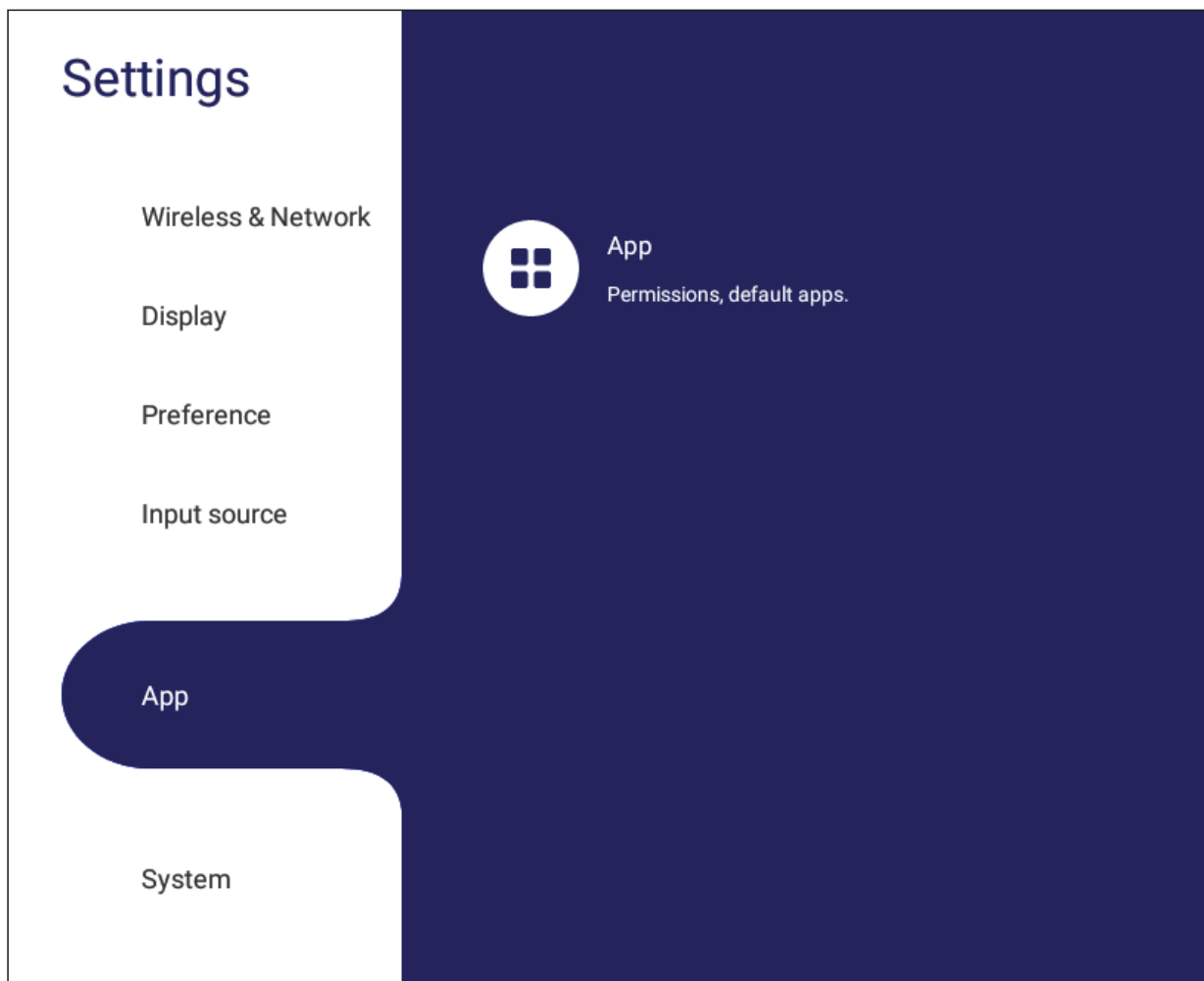

NOTE:

- Pre-loaded apps cannot be uninstalled.
- Not all apps support the move to USB storage feature.
- Not all apps support Clear Defaults.

APP

View any running or installed applications. Tap on them for more detailed information and options.

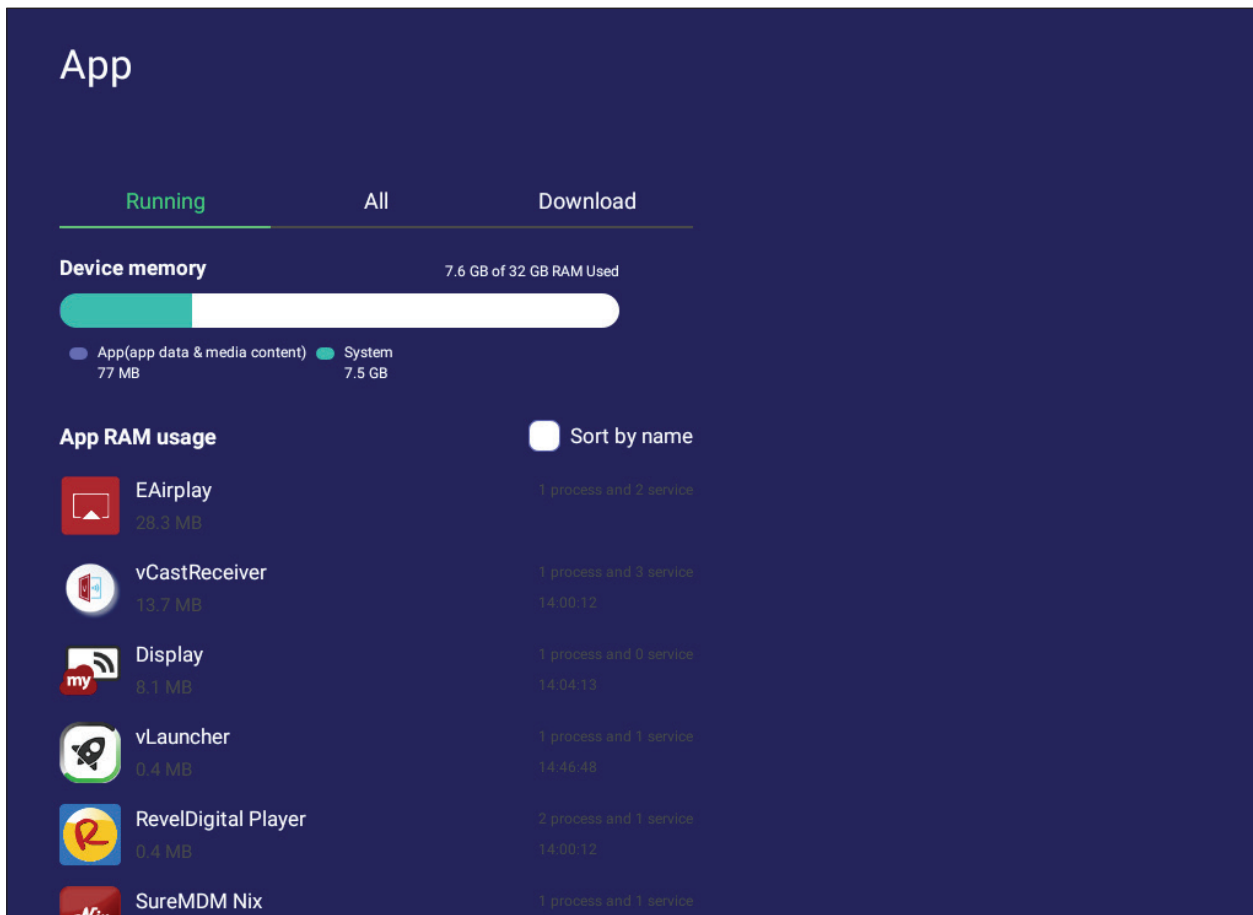

- By tapping on a running application, you can see more information, stop, or report the application.

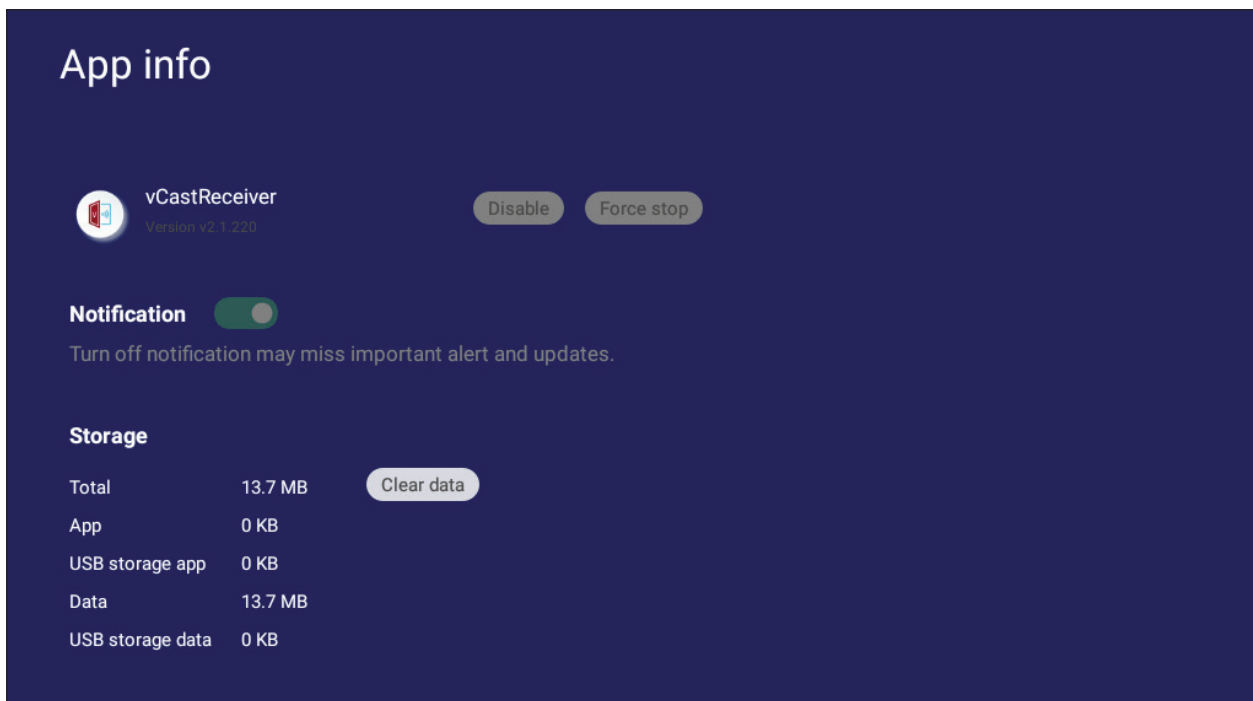

- Selecting **All**, **Download**, or **USB storage** will list all installed applications.

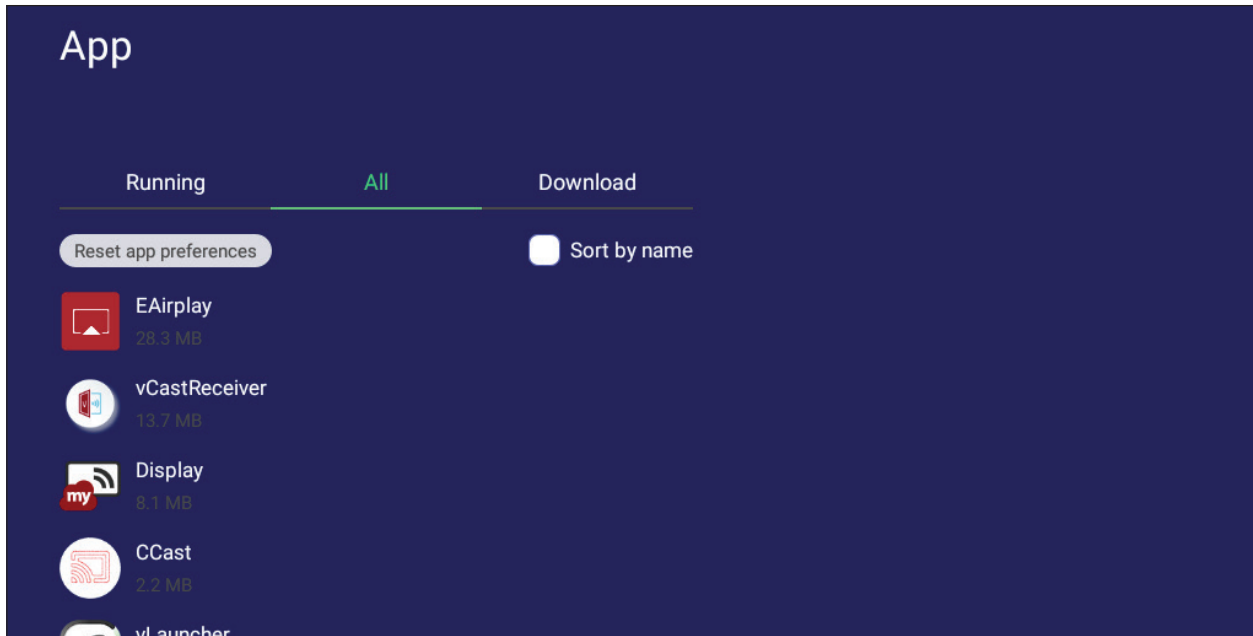

- Tapping on any application will display further information and options.

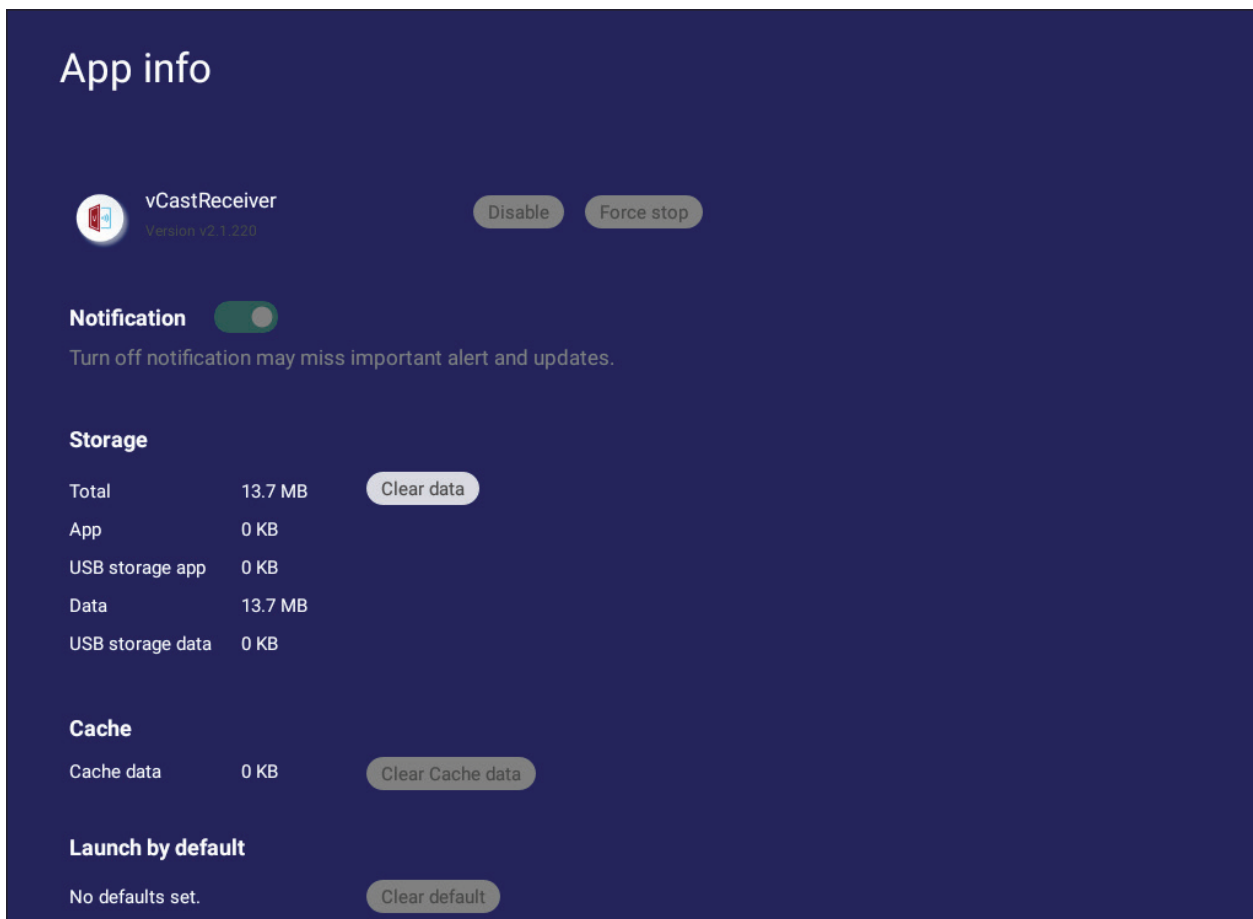

System

View and adjust **Storage**, **Security**, **System Update**, and **About device** settings.

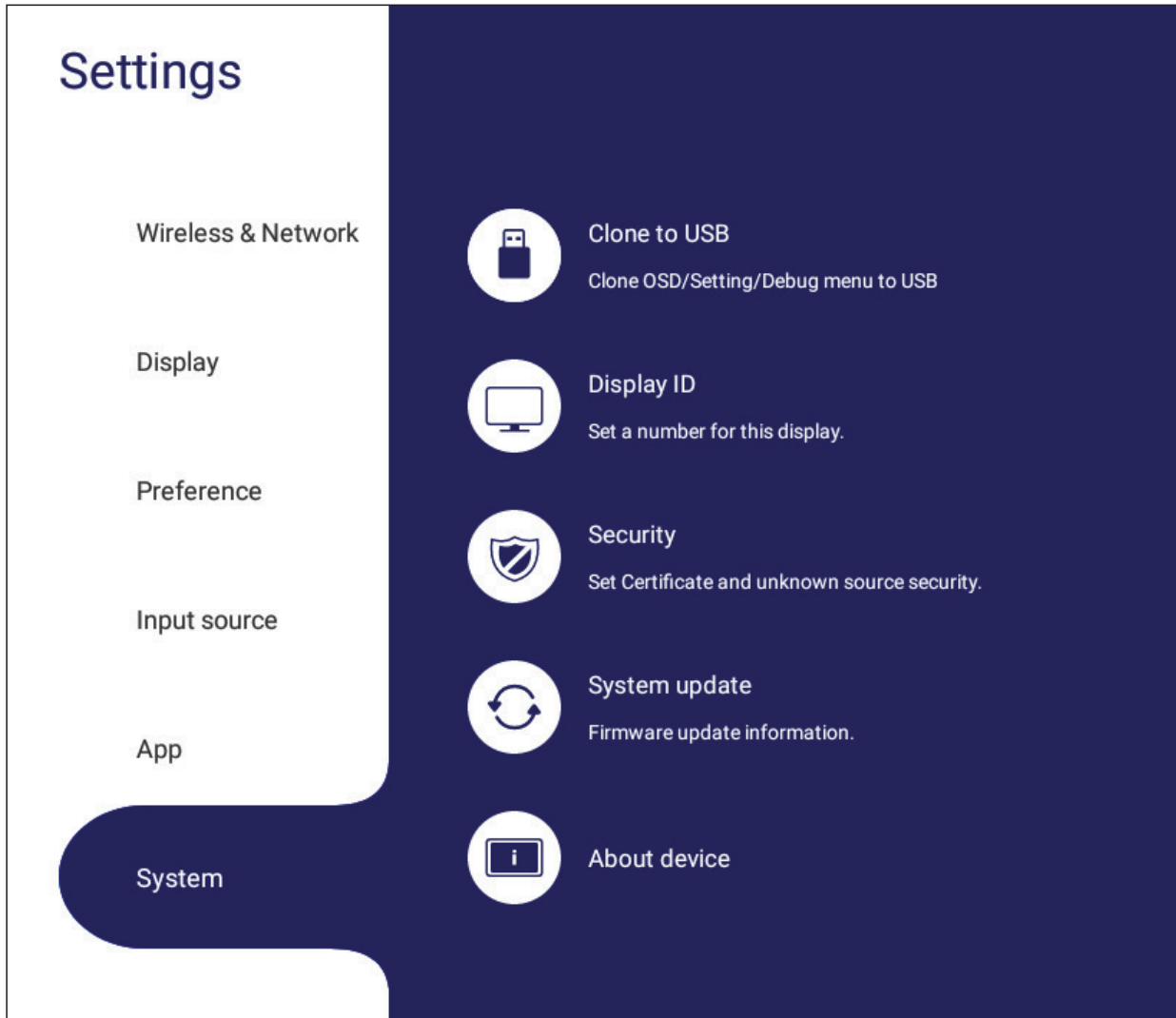

Clone to USB

Copy settings to an external USB drive.

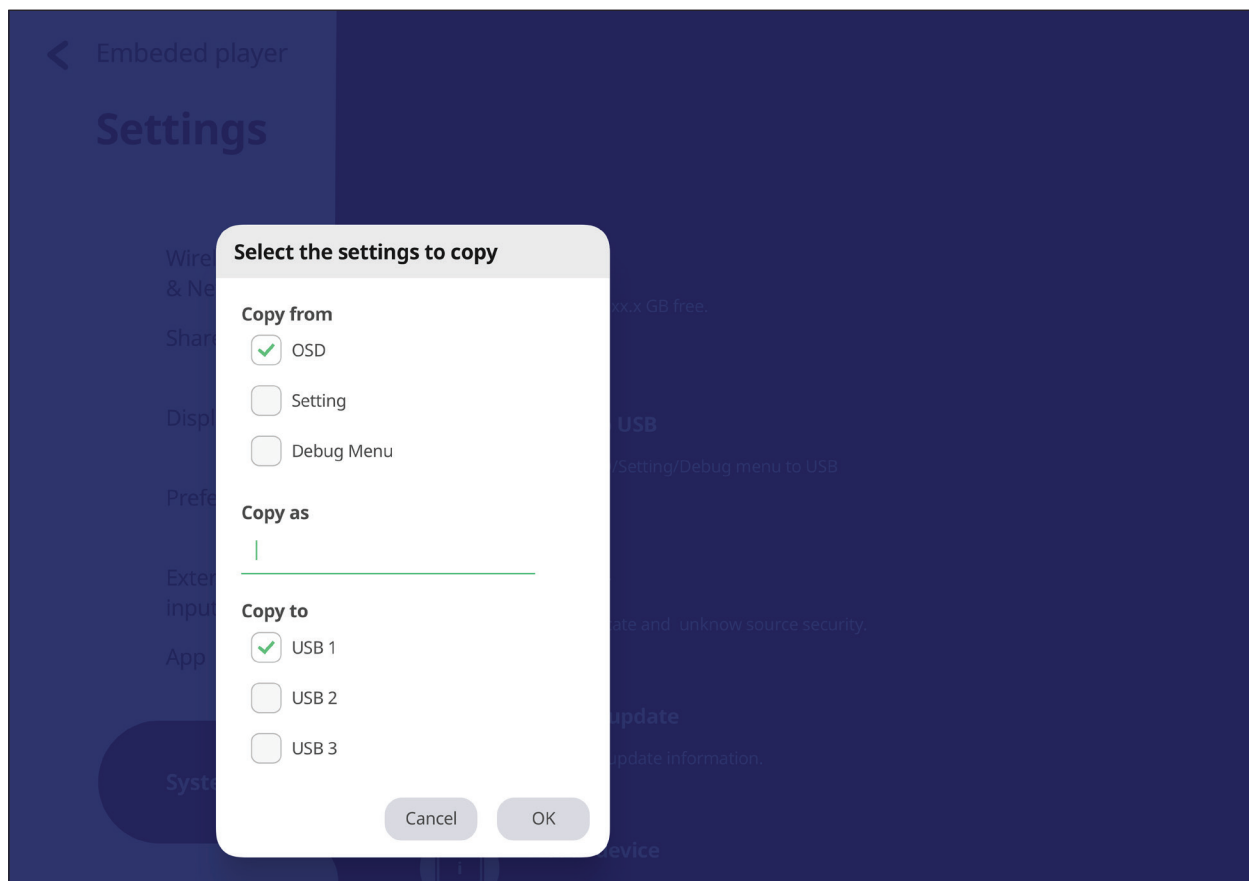

Display ID

Assign a number to remote control the display by RS-232/LAN.

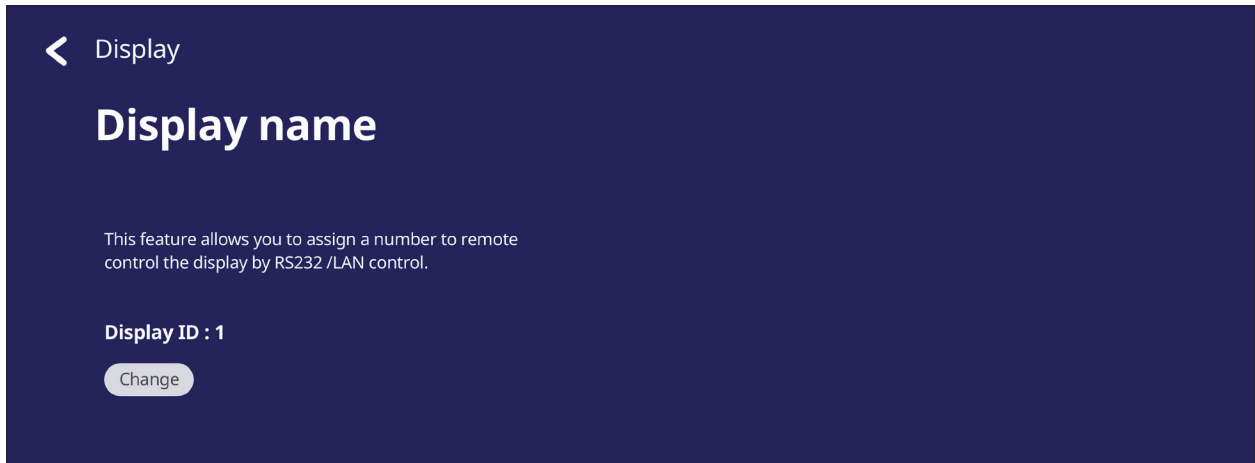

- To assign or change the Display ID, tap **Change** and input a number.

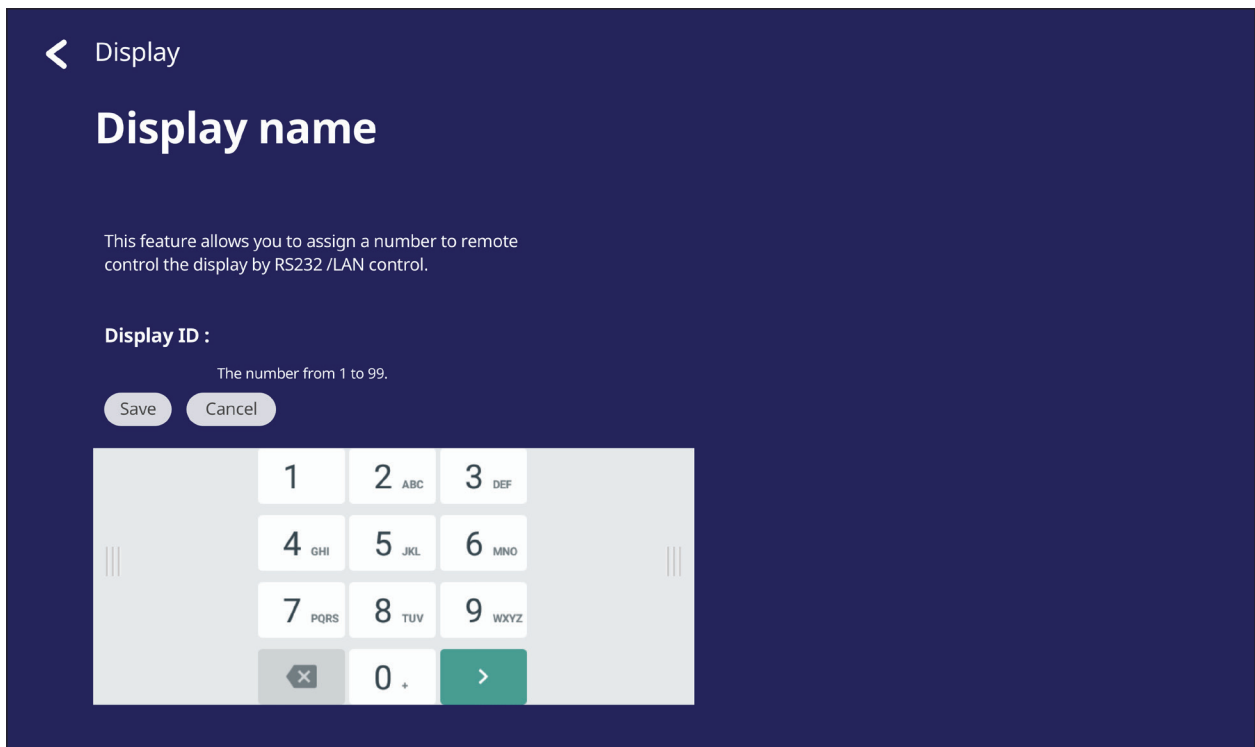

NOTE: The Display ID is for RS-232 users, and the range is 01~99.

Security

Review **Certificate**, **Trusted Credential** storage, and **Unknown sources** install settings.

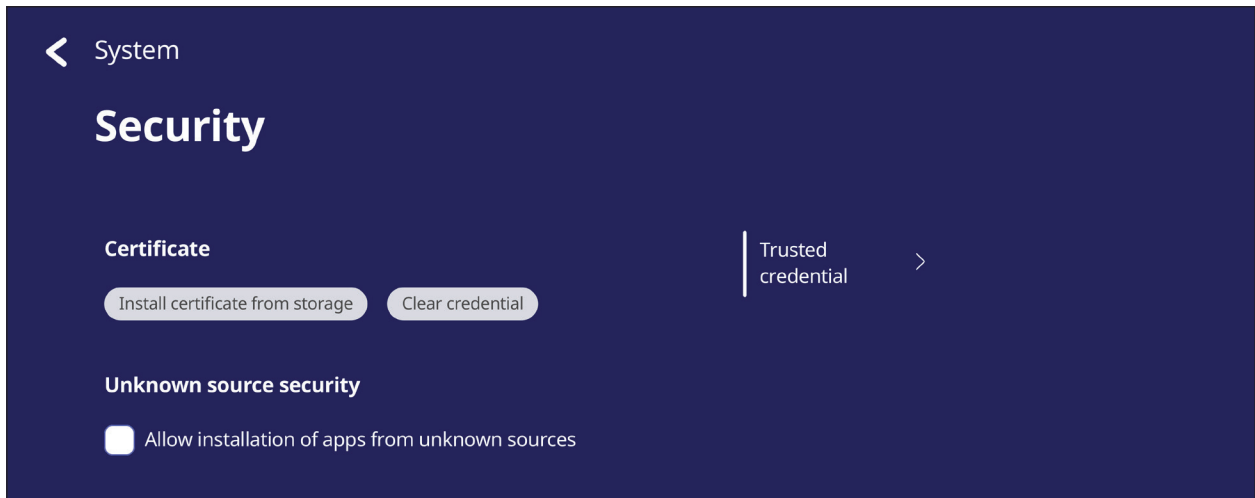

- Tap on **Install certificate from storage** to add additional certificates.

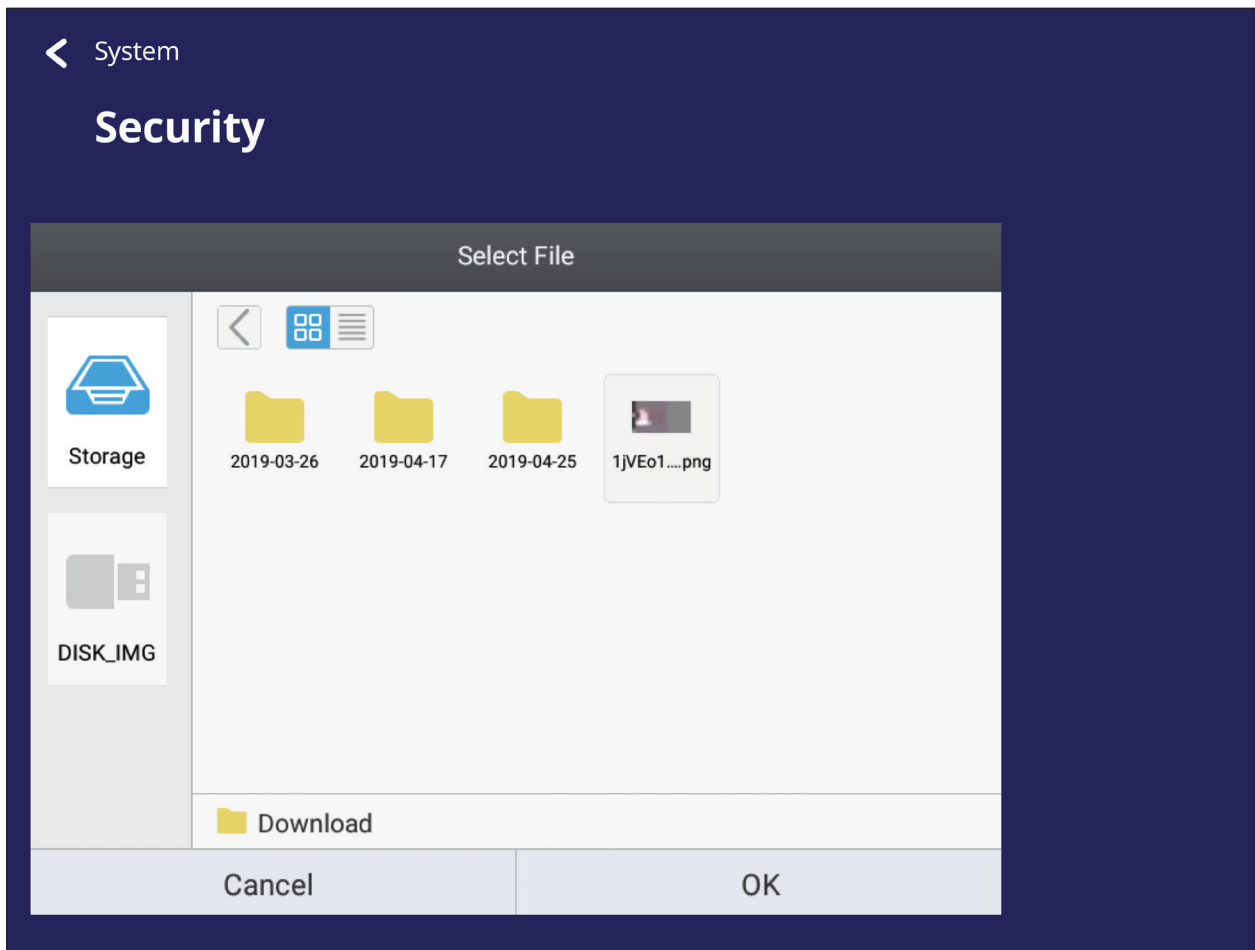

- Selecting **Clear Credentials** will remove all manually installed credentials.

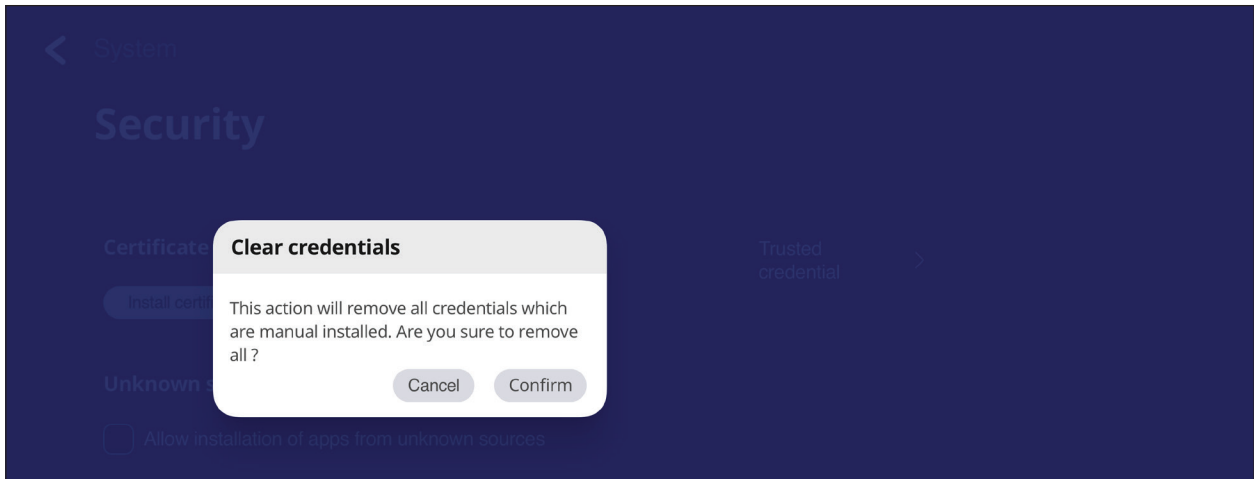

NOTE: Pre-loaded credentials cannot be cleared.

- Under **Trusted Credentials** view and edit all trusted and installed CA certificates.

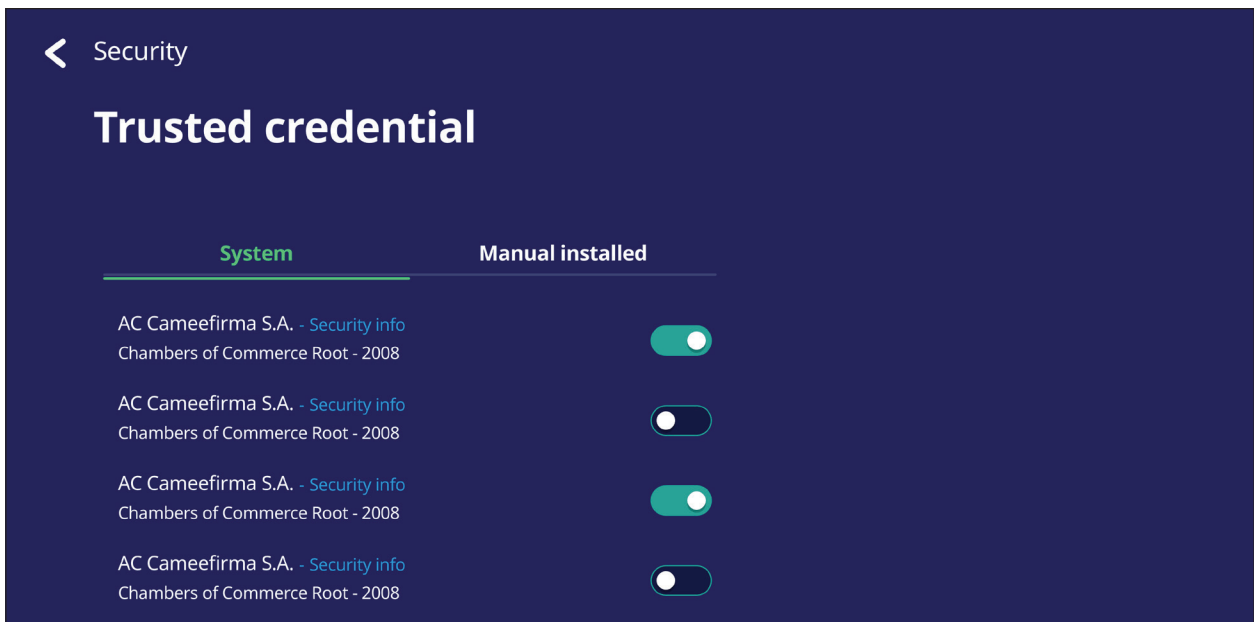

- Tapping on a credential will provide more detailed information.



- Allow the installation of applications from unknown sources by selecting the box under **Unknown source security**.

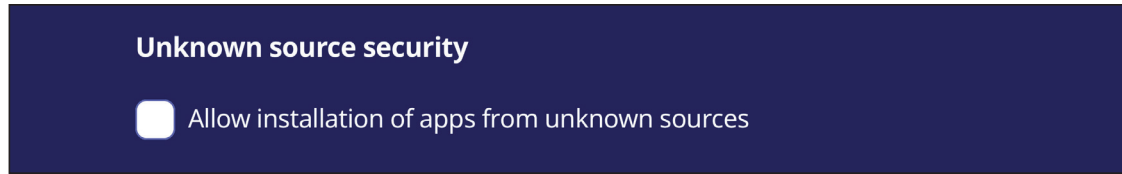

NOTE: Apps from unknown sources may not be compatible or work properly.

System Update

The ViewBoard automatically searches for software updates whenever connected to the Internet (OTA). With just one click, users can update their version of ViewBoard software.

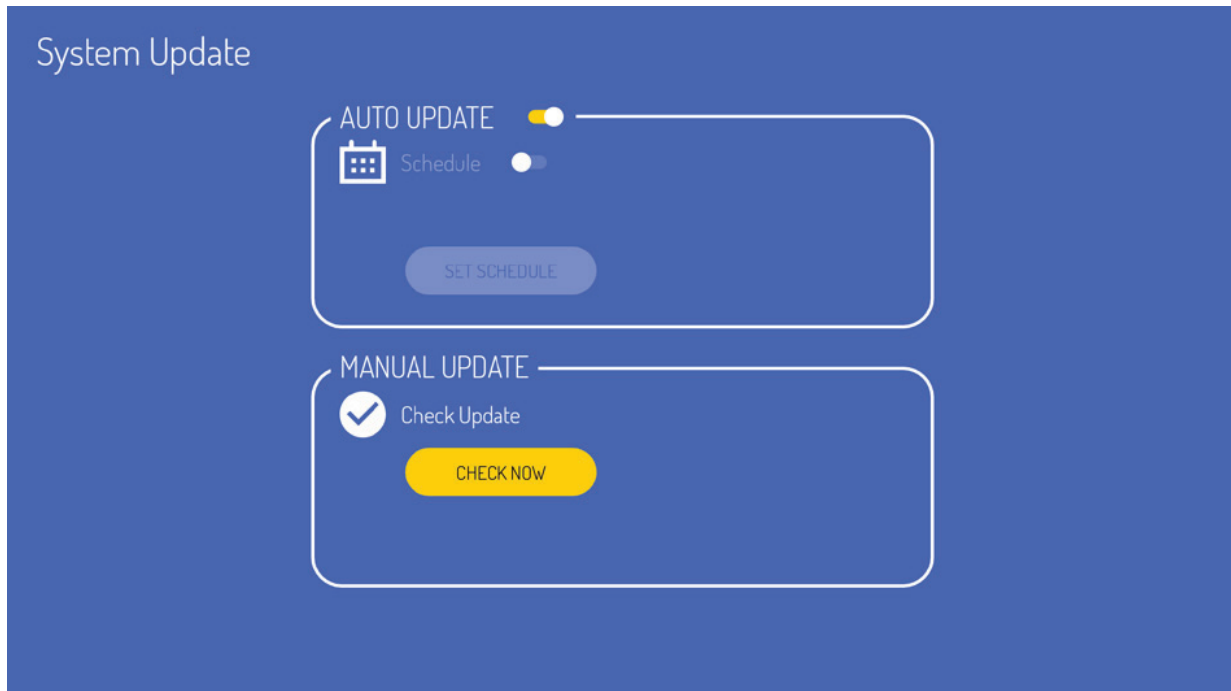

Item	Description
Auto Update	When the display is off, the system will automatically check for a new version. If a new version is found, the system will automatically update. After the update is complete, the system will turn off.
Schedule	Set the update time.
Manual Update	Update the software manually.

About Device

Display Embedded Player information, **Legal information**, and **Asset Tagging**.

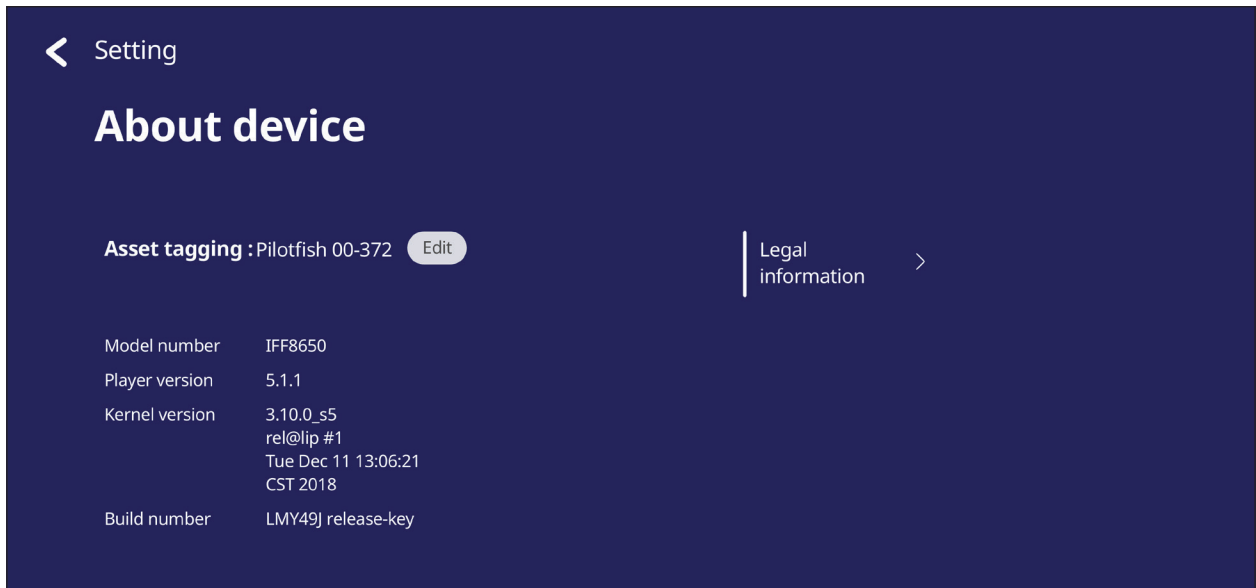

- By selecting **Edit**, the asset information can be adjusted.

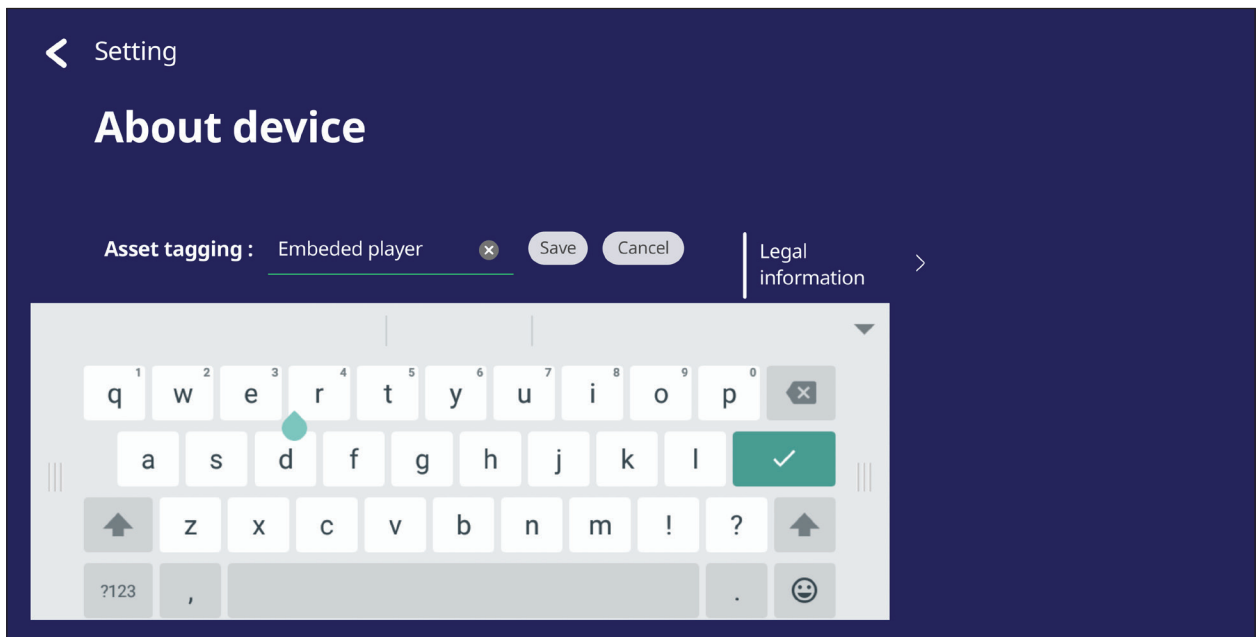

- Tap on **Legal information** to check open source licenses.

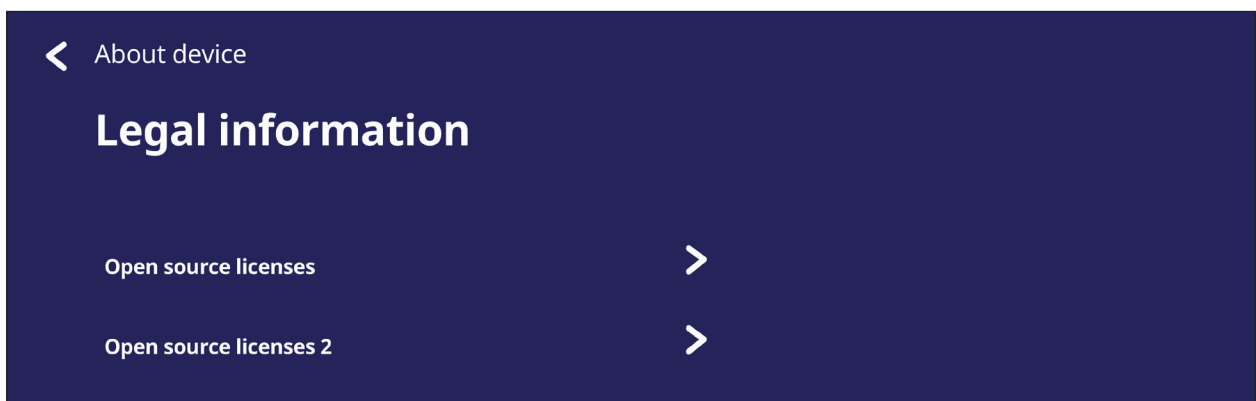

Embedded Applications and Settings

Embedded Digital Whiteboarding App

Within ViewBoard, ViewSonic offers the embedded digital whiteboarding app, myViewBoard.







myViewBoard

Floating Bar

		Move the Floating Bar.	
		Switch between presentation and preparation modes.	
		Paste from the clipboard onto the canvas.	
		Click to open the web browser	
		Go to the previous canvas.	1. New myViewBoard File 2. Open File 3. Save File
		Go to the next canvas.	
		Add a new canvas.	

Toolbar

		Full Screen Capture	
		Toolbar Move Button	Select and hold to move the toolbar to the left side, right side, or bottom of the screen.
		File Button	
		1. New myViewBoard File 2. Open File 3. Save File	4. Save as File 5. Export 6. Email
		Import resources (image, video, audio, etc.) to the whiteboard.	
		Infinite Canvas Button	Select – Use two hands to zoom in/out on/of the working panel.
		Selection Button	Select objects, text, and pictures to get other tools.
		Pen Button	Writing tools, changing colors, transparency, thickness, etc.
		Eraser to erase objects or clear the page.	
		Shape/Line Button	Create shapes, select shape colors, insert arrows.

	Text Box	Creates a Text box.
	Undo Button	Undo previous actions.
	Redo Button	Redo previous actions.
	Page Toggle Button	Select pages, sort pages, delete pages.
	Show or hide the current host information.	
	Whiteboard background management menu.	

ViewBoard Cast

NOTE: This is a paid feature. If you need to activate it please contact your local seller for more information.

Working with ViewBoard® Cast software, the vCastReceiver app, will allow the ViewBoard® to receive vCastSender laptop screens (Windows/Mac/Chrome) and mobile (iOS/Android) users' screens, photos, videos, annotations, and camera(s).

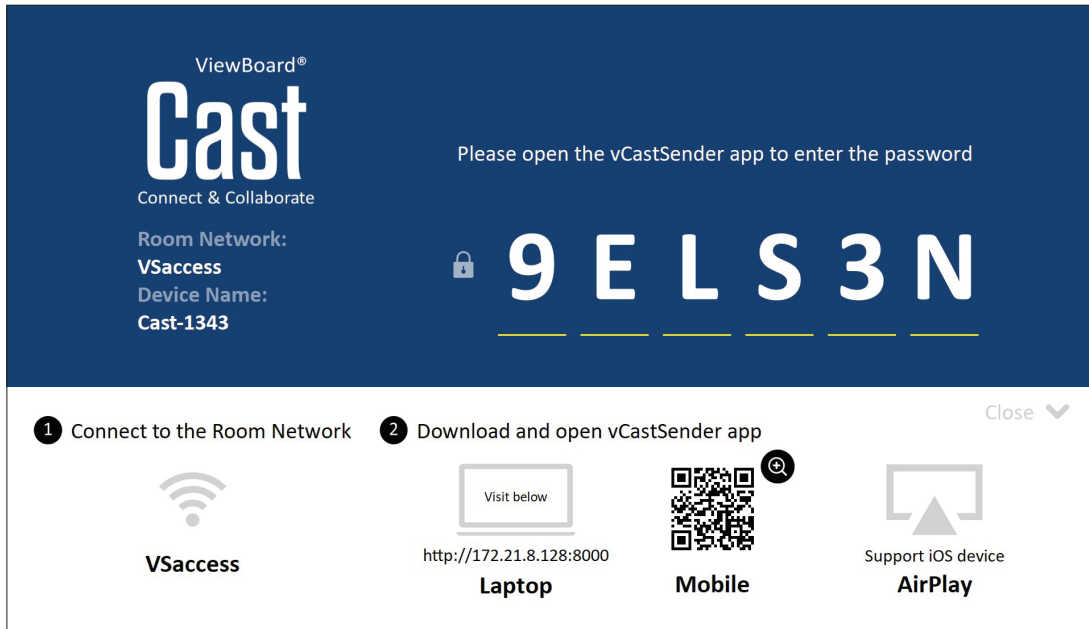

Network Information

- ViewBoard® Cast software, laptops, and mobile devices can connect to both the same subnet and across the subnet network.
- Connected devices will show up under “Device List” on the same subnet connection.
- If the device does not show up under “Device List”, users will need to key-in the on-screen PIN-code.

ViewBoard Cast is a wireless peer to peer data communication, therefore the below port settings are required:

Ports:

- CP: 56789, 25123, 8121, and 8000
- UDP: 48689 and 25123

Port and DNS activation:

- Port: 8001
- DNS: h1.ee-share.com

Cast Sender from Windows-based, Macbook, and Chrome devices.

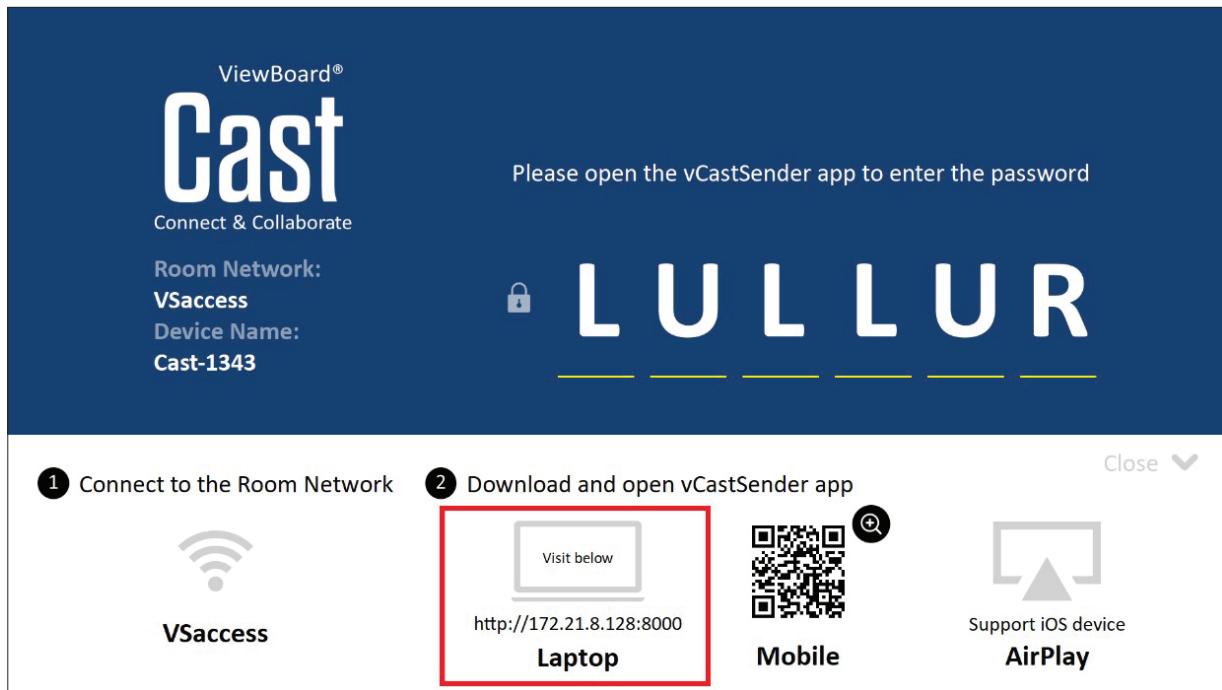

Mac, Windows, Chrome Devices:

1. Make sure your device is connected to the same network as the ViewBoard.
2. Visit the address that is shown on the ViewBoard to download the application.
3. Launch the application and click the connect icon next to the Device Name.

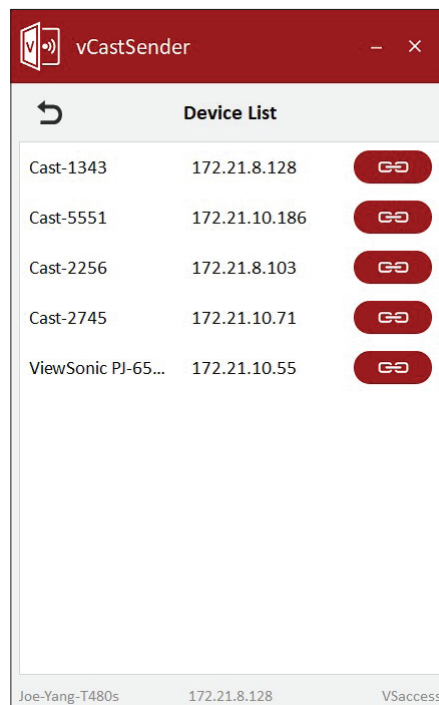

NOTE: If the device is not listed, click **Connect with PIN-Code** and input the pin-code displayed on the ViewBoard.

Cast Sender from Mobile Devices: iOS-based (iPhone, iPad) and Android OS based phone/tablet.

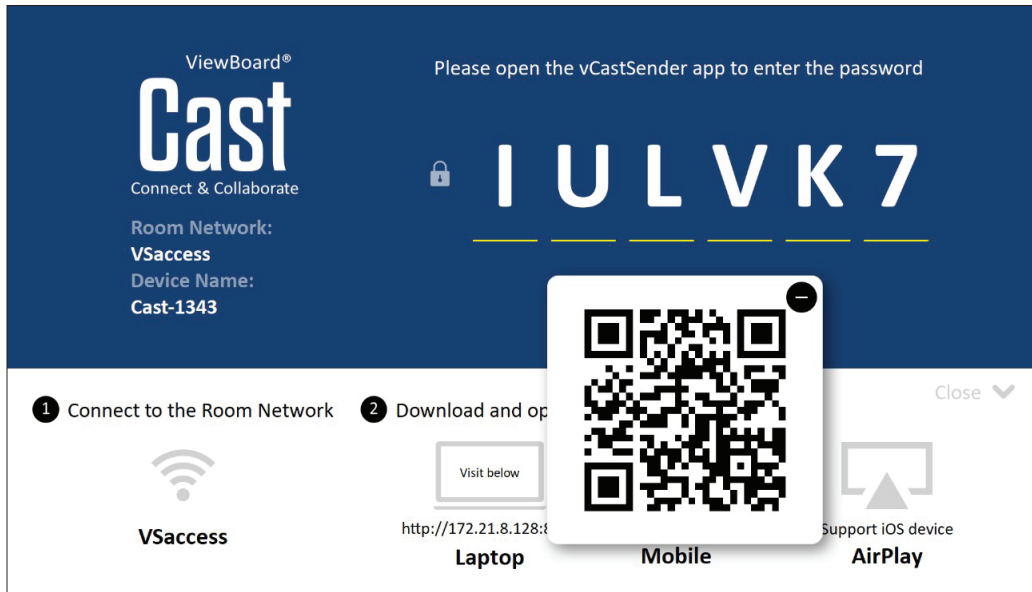

Android/iOS:

1. Make sure your device is connected to the same network as the ViewBoard.
2. Scan the QR Code that is shown on the ViewBoard to download directly from the server, or download from the Google Play Store or the Apple Store.
3. Launch the application and select the correct Device Name and input the pin to connect. You can also directly input the pin-code displayed on the ViewBoard to connect.





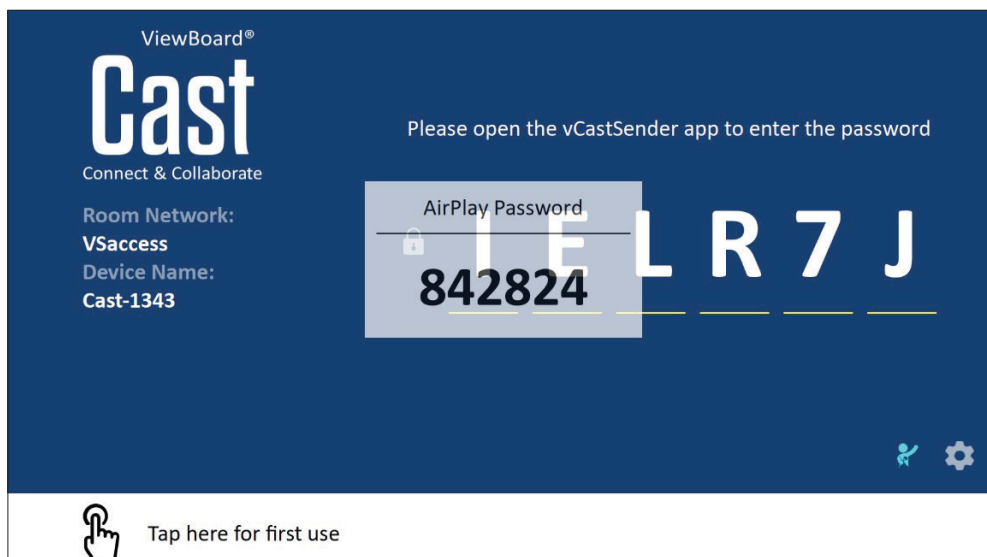

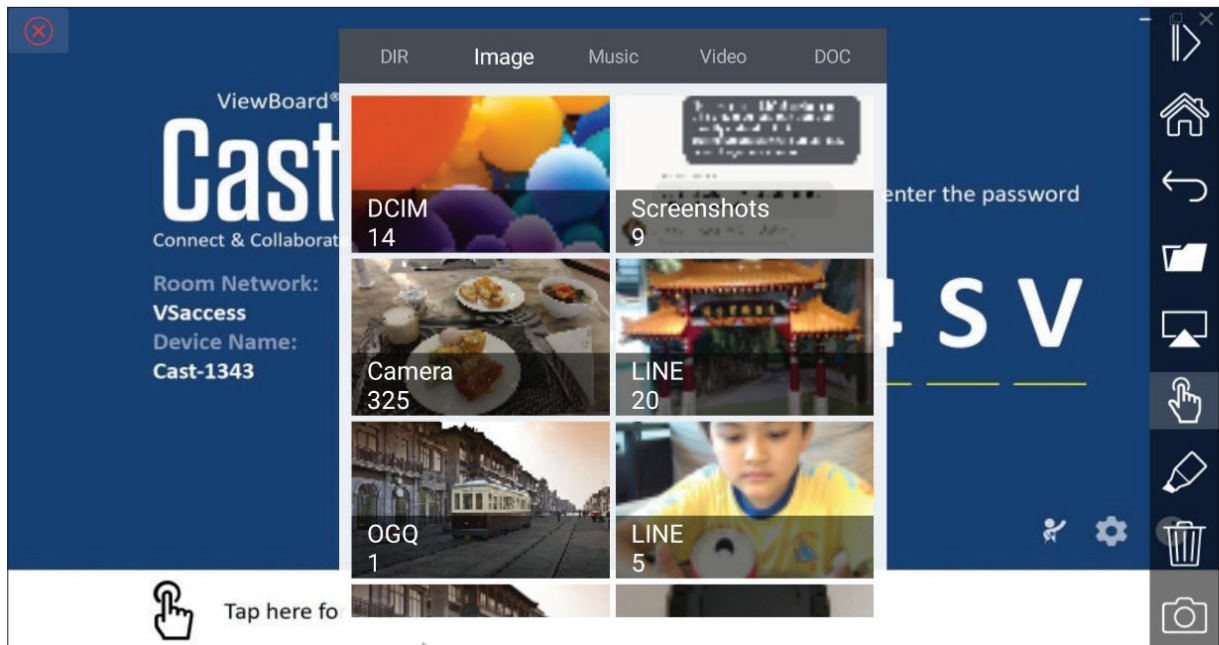

Apple AirPlay®:

1. Make sure your device is connected to the same network as the ViewBoard.
2. Directly open AirPlay and select the Device Name to connect.
3. Another "AirPlay Password" will be generated on-screen for connection.



Cast Out from a Mobile Device that Supports Annotation



Item	Description
 Toggle	Click to hide or display tool bar
 Home	Click to return to the Home interface
 Return	Click to return to previous operation interface
 Folder	Click to view or open the mobile device's internal file
 Screen sharing	Click to share screen (Android 5.0 and above supported)
 Touch	Click to change to touch mode
 Pen	Click to make annotations, and to change color and thickness
 Clear	Click to clear everything on the screen
 Camera	Click to use the camera and send the image to the ViewBoard

Screen Recorder

Capture everything that is displayed on screen in a video format.

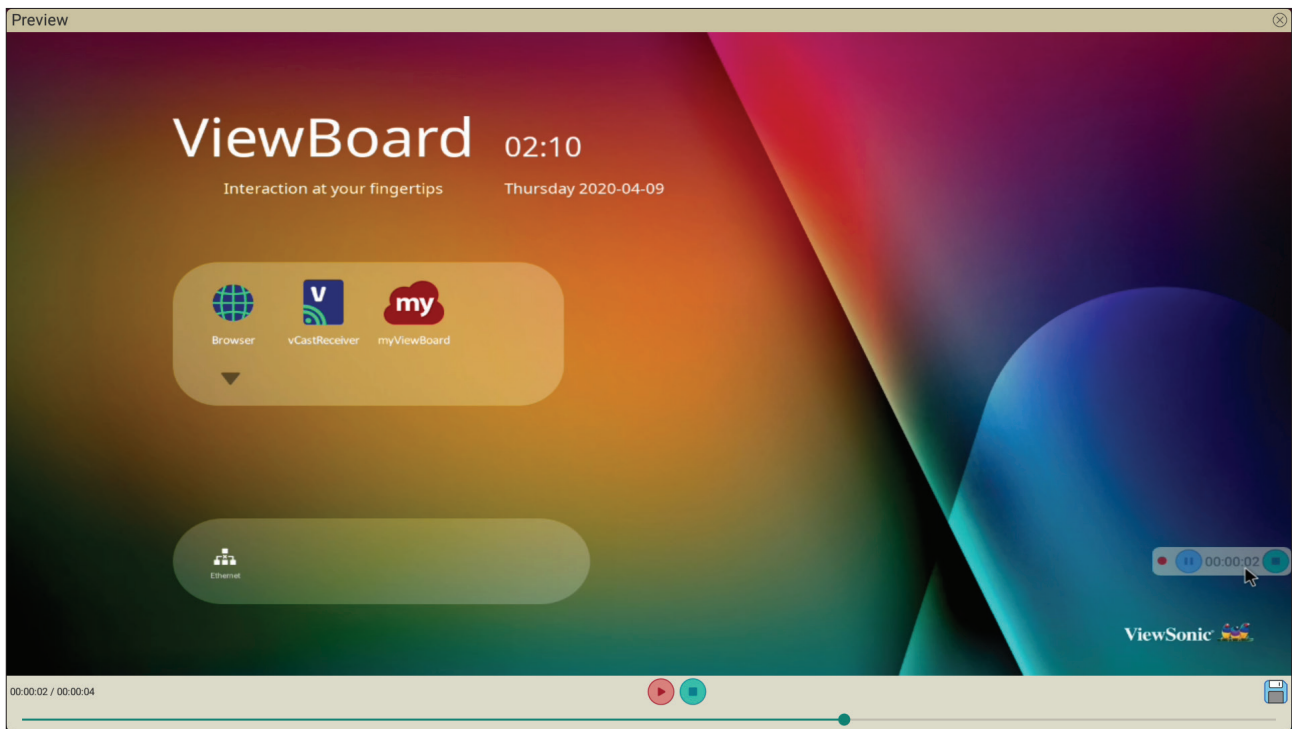

To launch the Screen Recorder application:

1. Select the Screen Recorder icon in the application drawer.
2. Tap the record icon  and select the preferred recording configurations. Then tap the check mark.

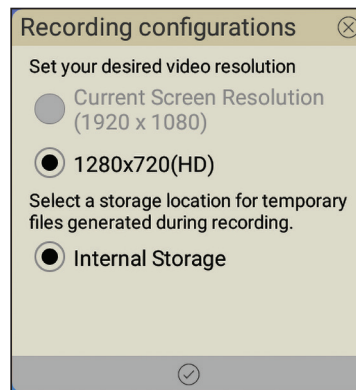

3. Select *Start Now* and a three (3) second countdown will begin. Screen recording will begin immediately after the countdown.
4. After stopping the recording, you will be able to preview the video, save it, or discard it.

Air Class

Display quiz questions on the ViewBoard and allow up to 30 mobile users to submit answers remotely. Whether deploying single or multiple choice questions, the ViewBoard will record the results for each device being used.

Air Class

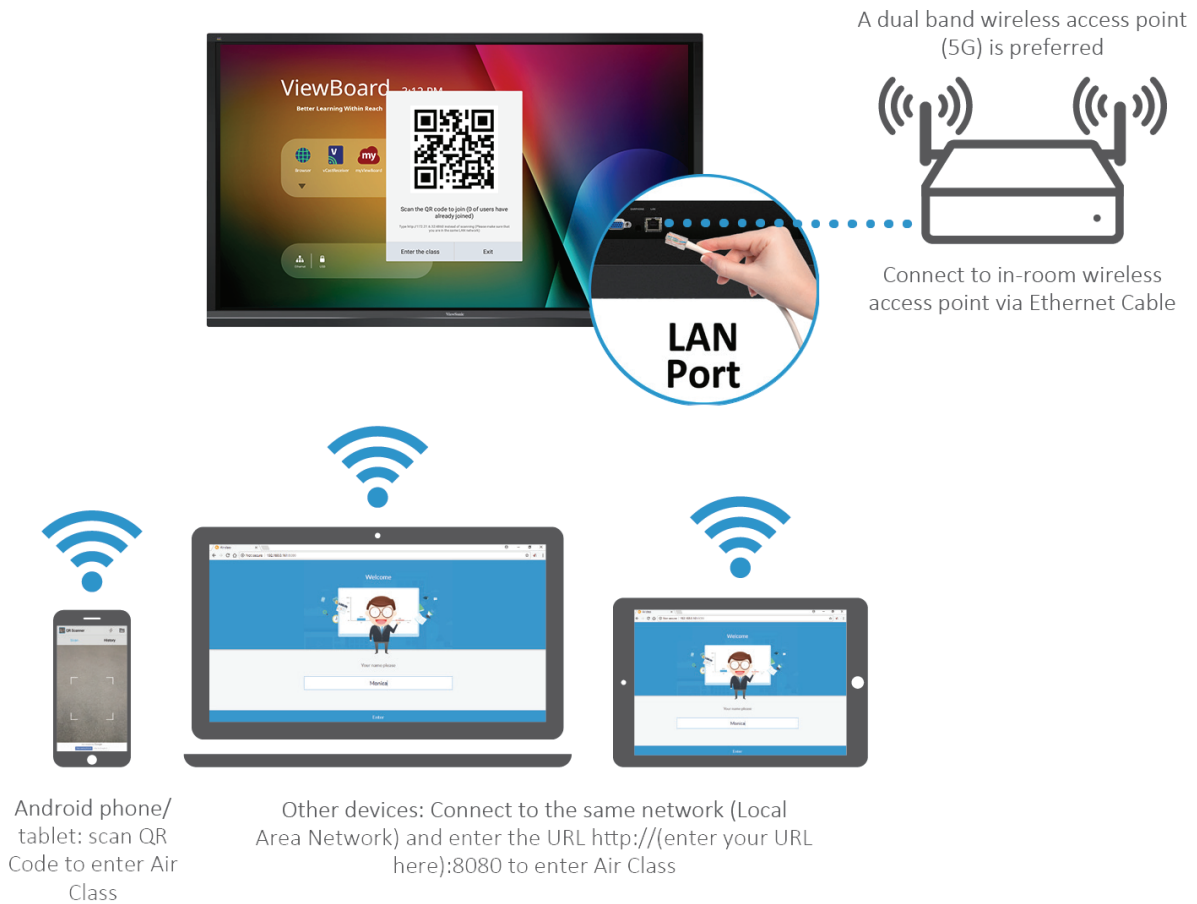

Network Information

- PC (Windows/Mac/Chromebook) and tablet/mobile (iOS/Android) devices, as well as the ViewBoard need to be linked to the same LAN network subnet.
- Ports: TCP 8080





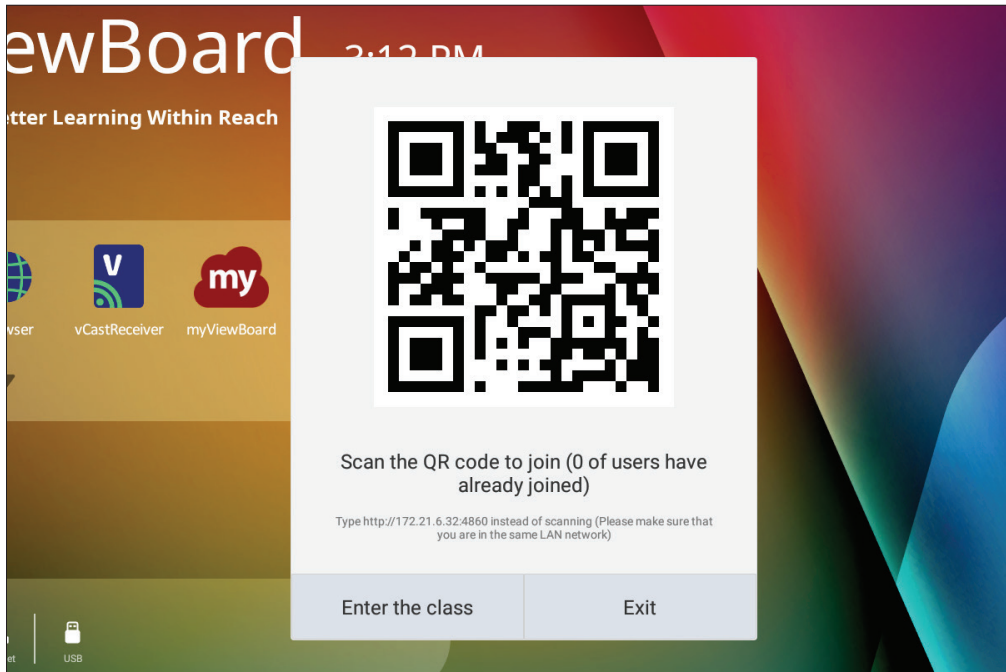

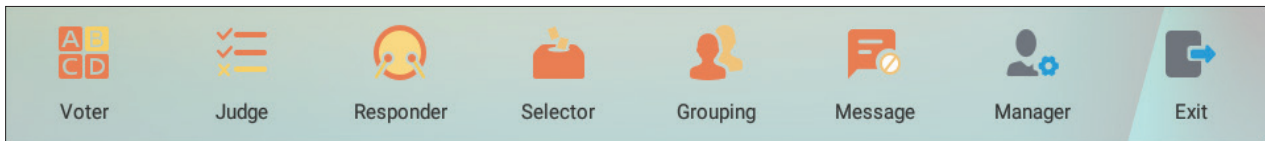

To launch Air Class:

1. Tap the tool bar trigger icon and select the more tools icon. Then select the Air Class icon.
2. Select “Enter the class”.



3. Choose from the available interactive functions at the bottom of the screen.



Item	Description
 Voter	Single and Multiple choice questions.
 Judge	True/False questions.
 Responder	Race to answer first.
 Selector	Randomly select a participant.
 Grouping	Assign participants to groups.
 Message	Allow/Deny participants to direct message the ViewBoard.
 Manager	Add participants.
 Exit	Exit Air Class.

Voter

1. Select the **Single choice** or **Multiple choice** icon to select the preferred answer type.

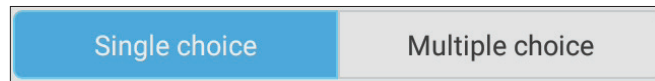

2. Tap **BEGIN VOTING** to let the participants start.

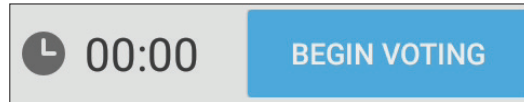

3. After the participants are finished and press **OK**, the ViewBoard will show the participant's name on screen.

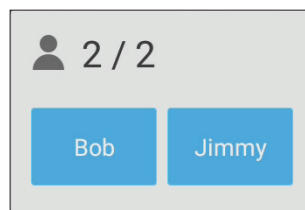

4. Tap **FINISH VOTING** to close the quiz.

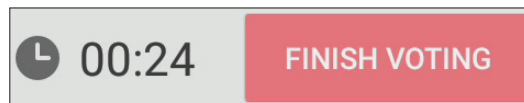

5. Then the participants' "Answer Statistics" will be displayed.

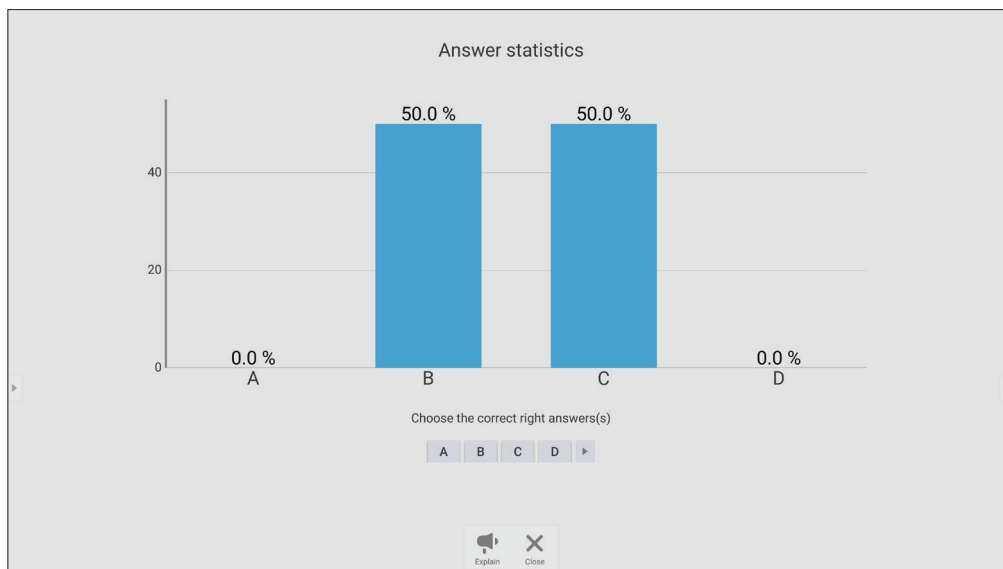

6. Choose the right answer to show the correct rate.

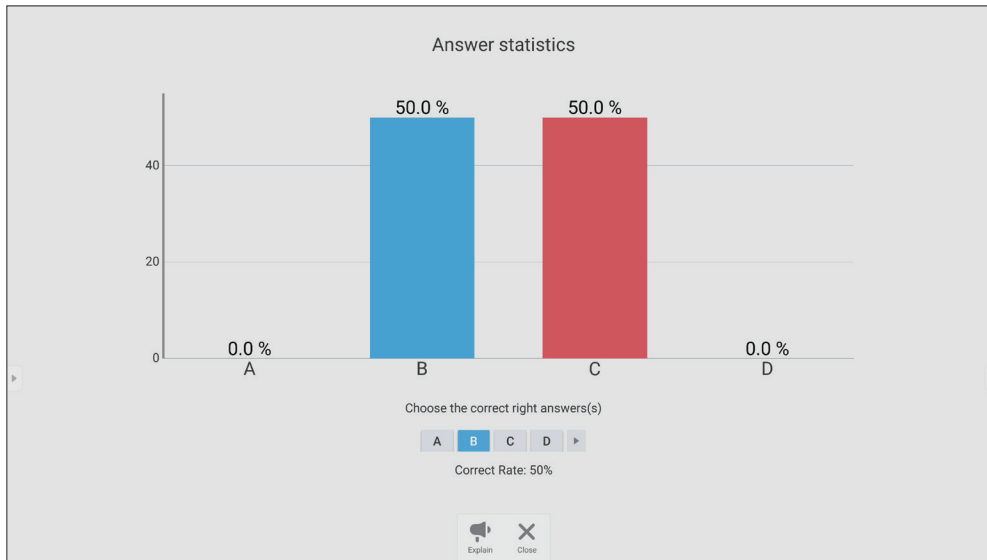

7. Click the Explain icon () to further analyze the topic.

$2 \times 3 =$

A. 7 C. 9

B. 6 D. 4

Answer statistics

Option	Percentage
A	0.0 %
B	50.0 %
C	50.0 %
D	0.0 %

Voter Judge Responder Selector Message Manager Exit

Judge

1. Tap **BEGIN VOTING** to let the participants start a True/False questionnaire.

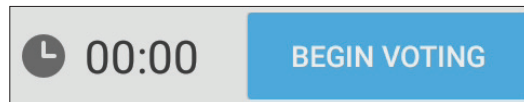

2. After the participants are finished and press **OK**, the ViewBoard will show the participant's name on screen.

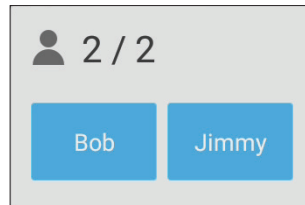

3. Tap **FINISH VOTING** to close the quiz.

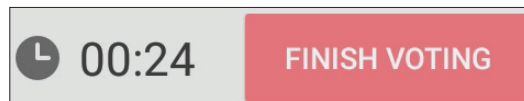

4. Then the participants' "Answer Statistics" will be displayed.



5. Choose the right answer to show the correct rate.

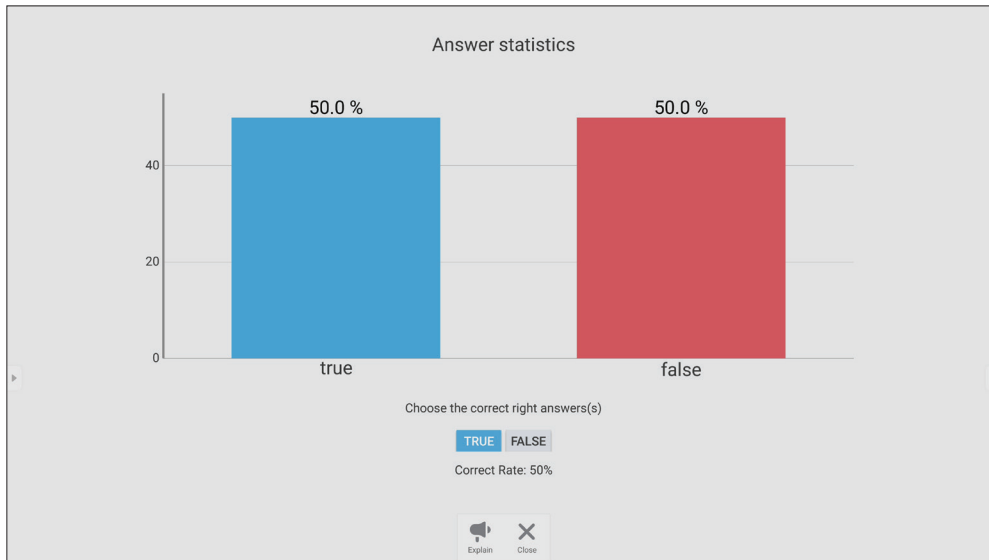

6. Click the Explain icon () to further analyze the topic.

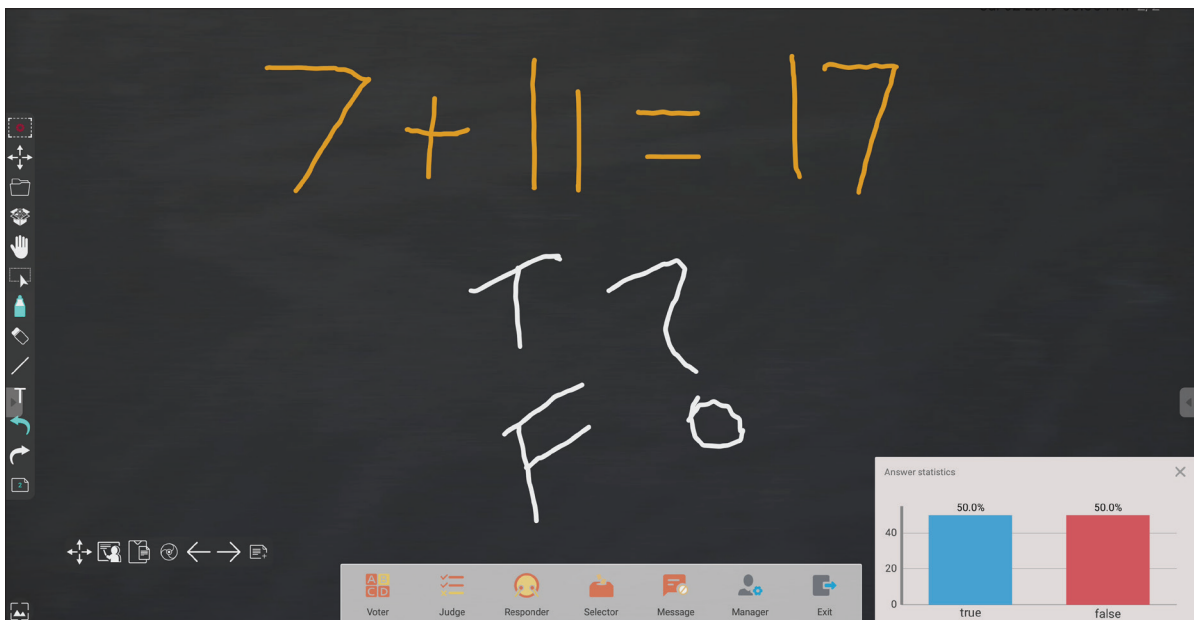

Responder

Participants race to select their answer and tap **OK** to submit their answer.

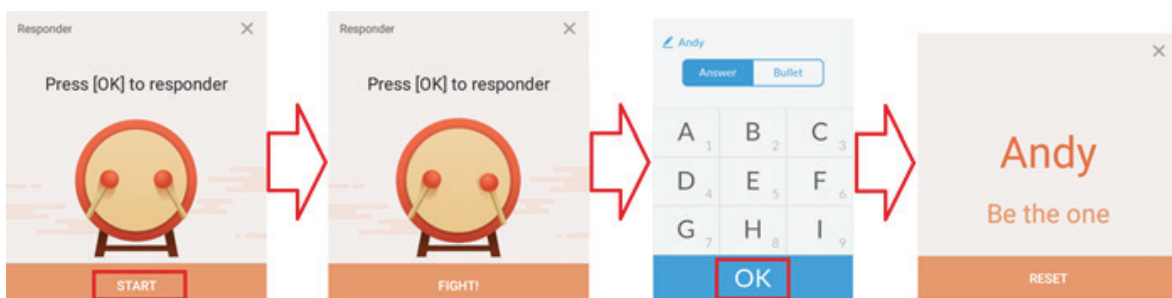

Selector

1. Select the “Selector’ icon.
2. Set the number of participants to be selected.

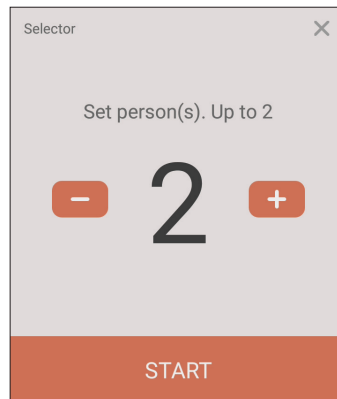

NOTE: The number of participants that can be selected will be based on the total number of participants.

3. Tap **START** to start the random selection.

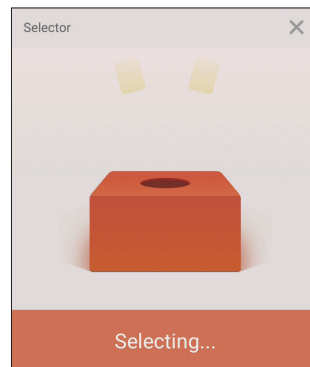

4. The selected participant’s name will then be displayed.

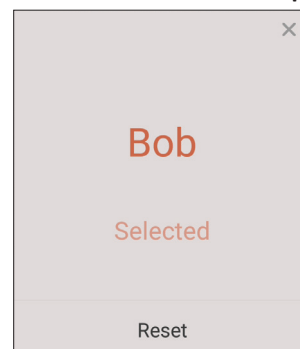

Grouping

Select the icon to assign participants to groups.

Message

To allow messaging:

1. Tap the “Message” icon to enable the function.
2. Participants select “Message” to change to the message interface.

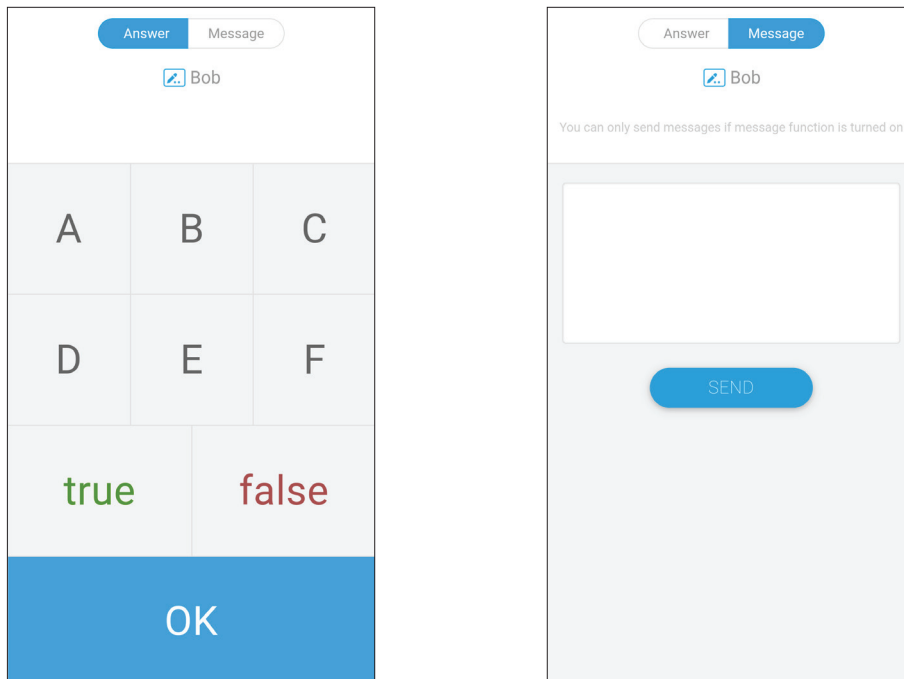

3. Participants key in their message then select **SEND**.

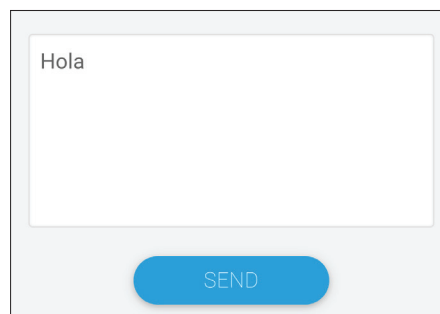

4. The message will scroll across the top of the ViewBoard.

Manager

Select the icon to let more participants join the class.

Exit

Select to exit the Air Class interface.

Other Default Applications

vSweeper

Clear unnecessary data and unwanted files.

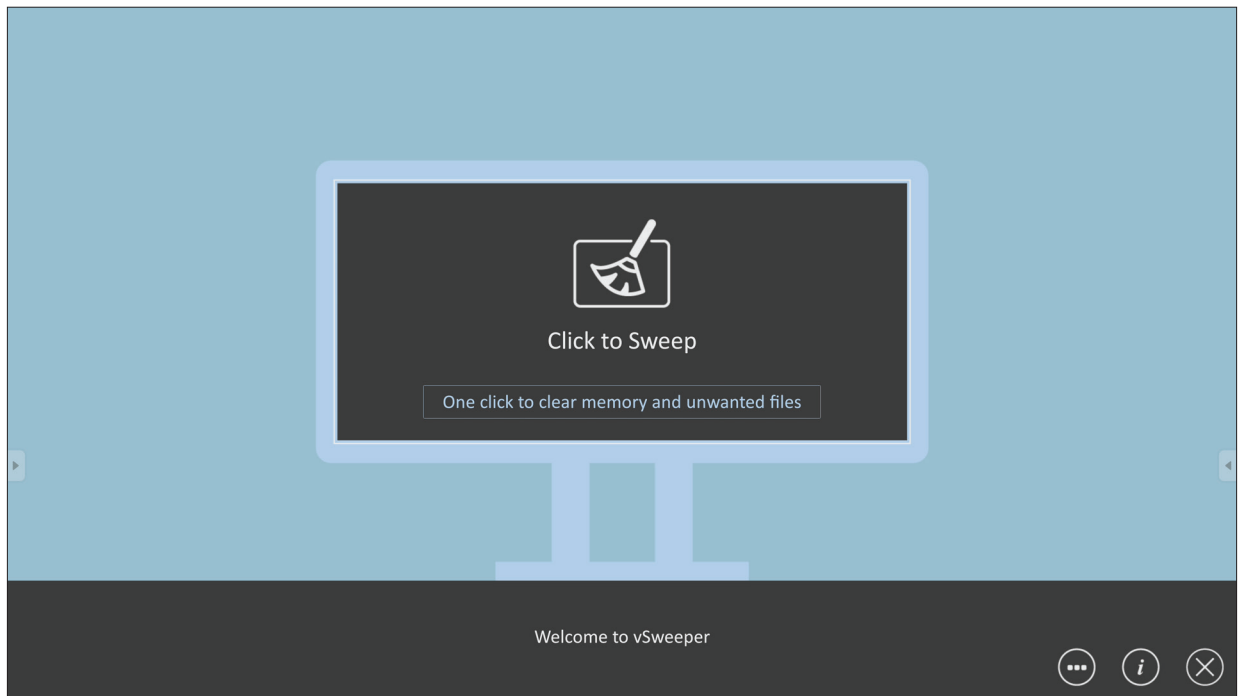

Advanced Settings can also be customized to the user's needs.

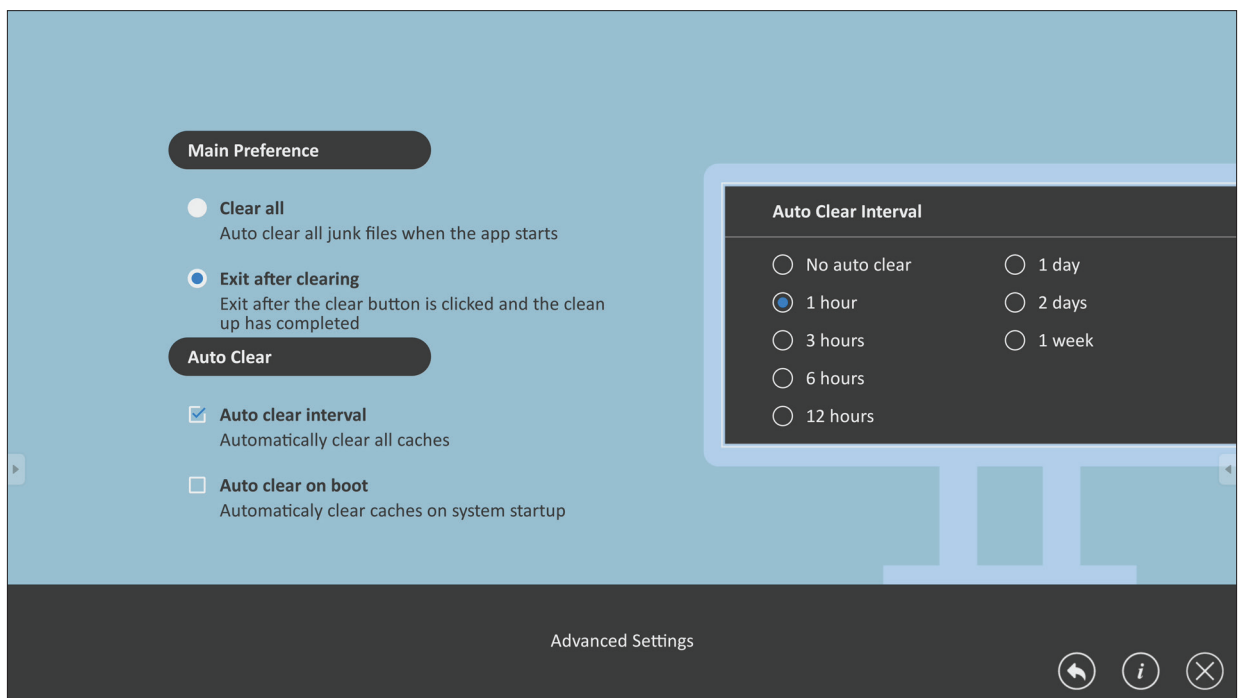

Screen Lock

Set a screen lock password and enable screen lock.

NOTE: If the user forgets the password, use the remote control and press **INPUT-0-2-1-4** to restore the password to default.

To set a screen lock password:

1. Go to: **Settings > Personal > Password for screen lock**, or select the Screen Lock icon in the apps list.

NOTE: If you select the Screen Lock icon and no password has been set, the below prompt will appear:

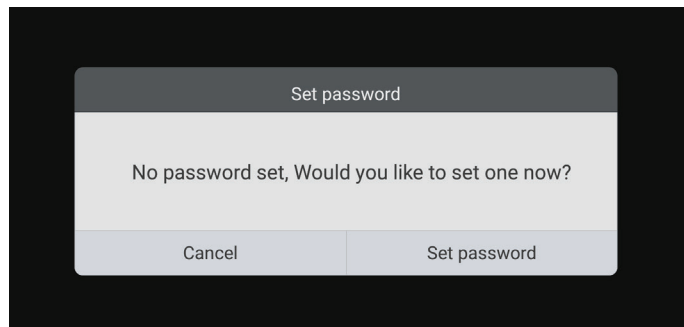

2. Select **Set Password**, and input a new four (4) digit password. Then select **OK**.

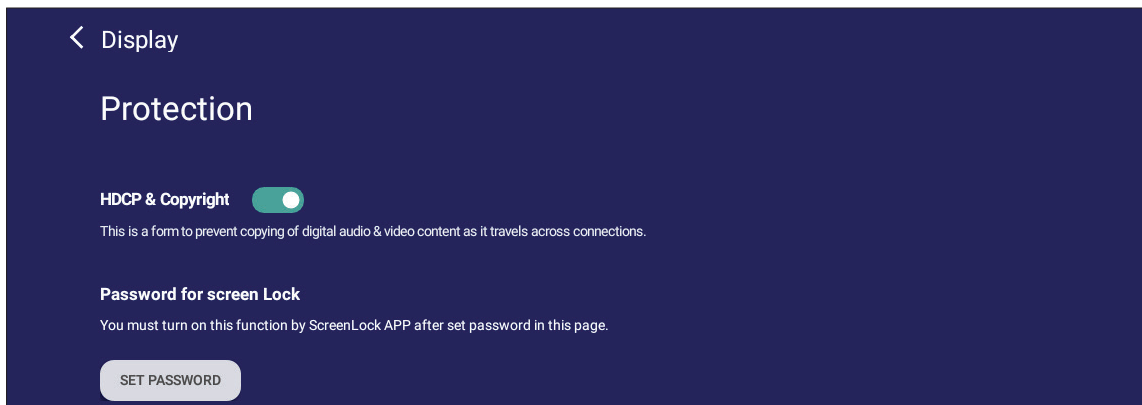

3. Now when selecting the Screen Lock icon, the screen will be locked.

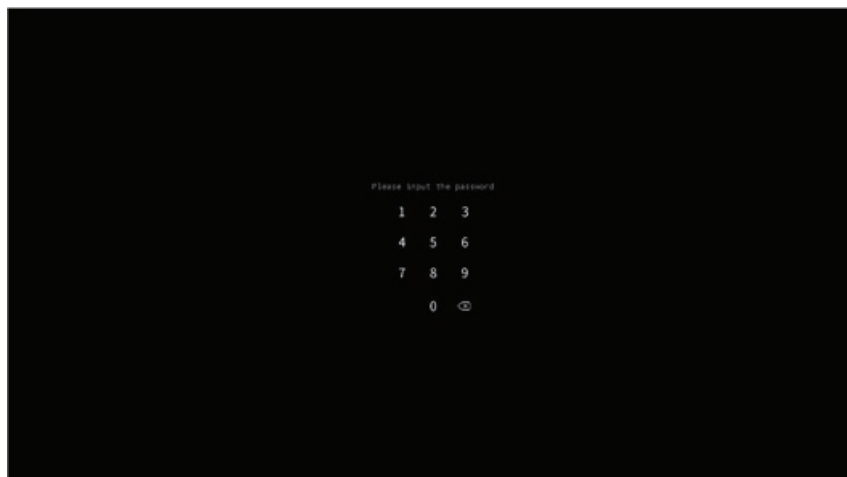

Chromium

Web browser for surfing the Internet.

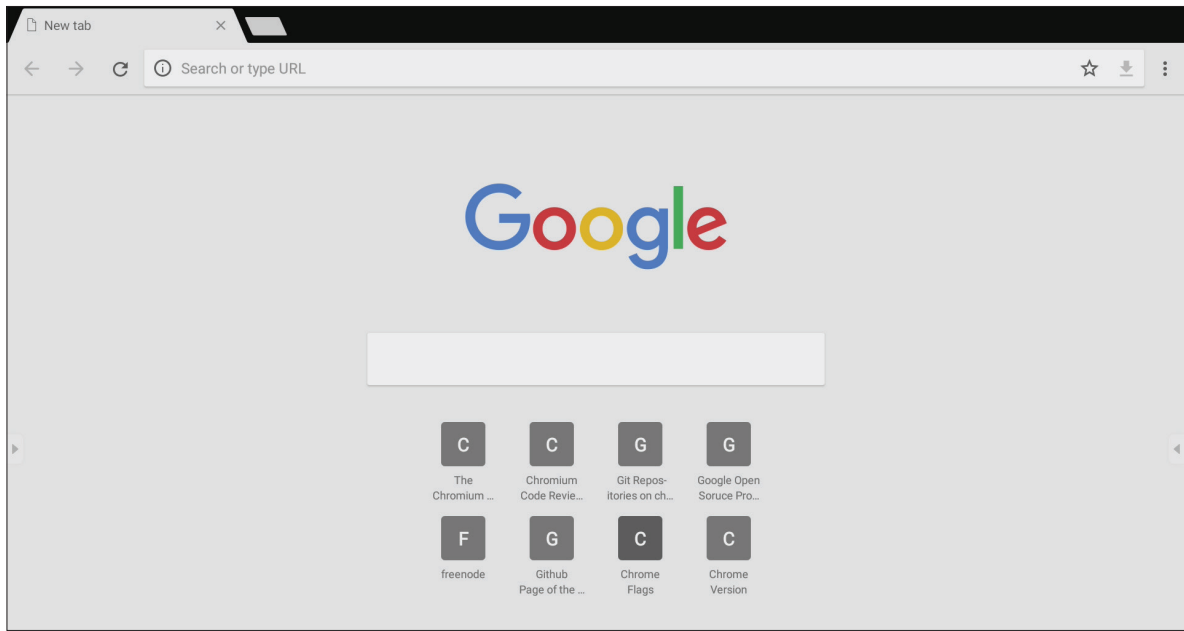

WPS Office

Create, edit, and view Documents, Memos, Presentations, and Spreadsheets.

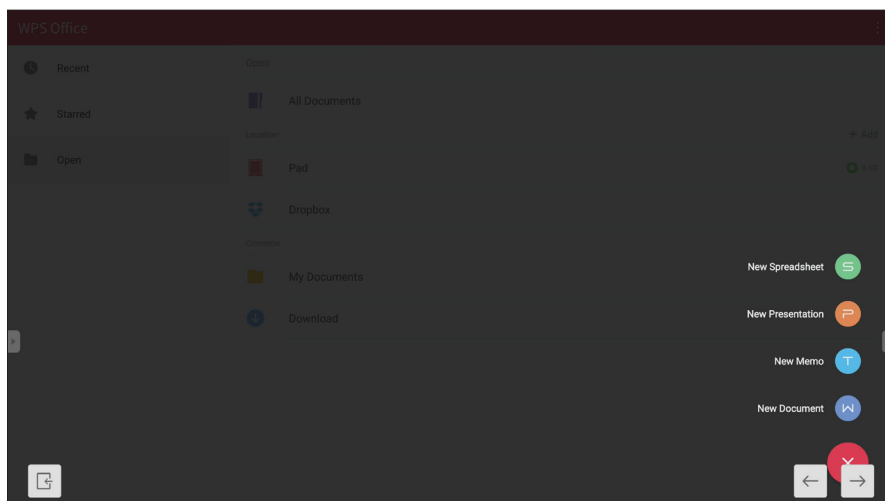
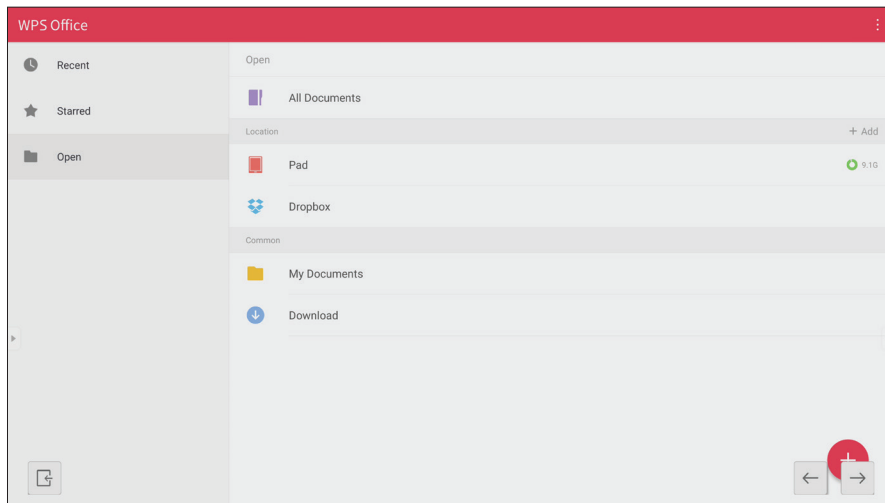

Folders

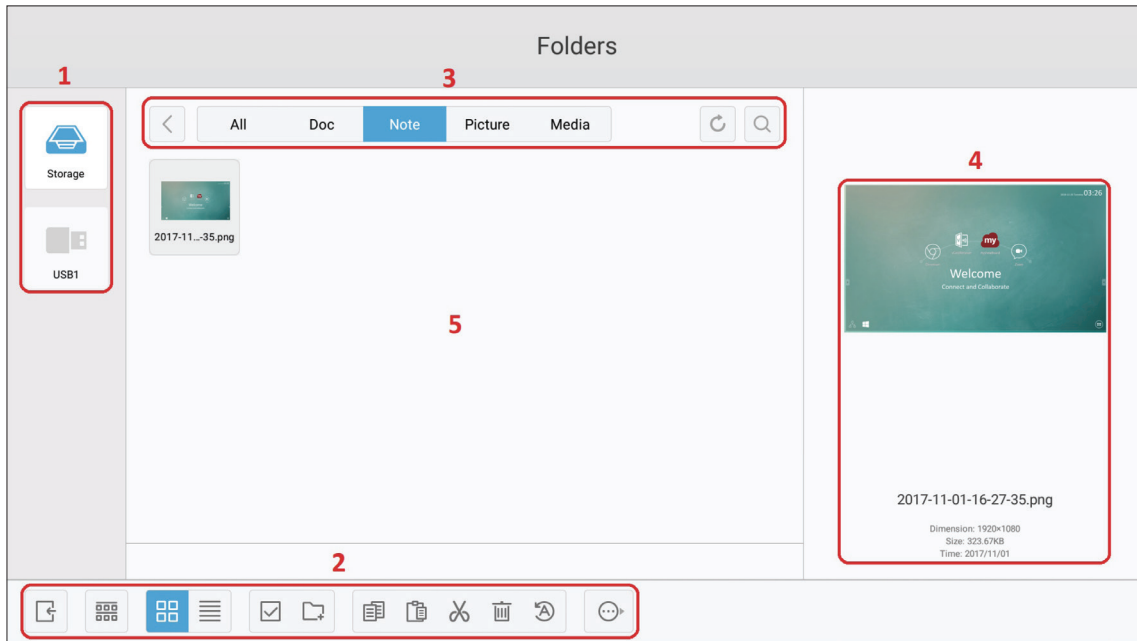

1. Storage Device Display

Select the appropriate storage device.

2. Icons

Item	Description
Exit	Click to exit.
Sort	Click to sort file.
Thumbnail	Click to display file by thumbnail mode.
List	Click to display file by list mode.
Select	Click to select file.
Add folder	Click to add folder.
Copy	Click to copy file.
Paste	Click to paste file.
Cut	Click to cut file.
Delete	Click to delete file.
Rename	Click to rename file.
More	Click to show more functions.

3. File Type Menu

Item	Description
All	All types
Doc	OFFICE files
Note	Image stored by myViewBoard, Side Tool Bar, and remote control Screen Capture button.
Picture	Image files
Media	Audio and Video files

4. File Information

Preview the image, show the image's name, size, resolution, and creation date.

5. Main Display Area

Display files of corresponding type.

RS-232 Protocol

This document describes the hardware interface spec and software protocols of RS-232 interface communication between ViewSonic LFD and PC or other control units with RS-232 protocol.

The protocol contains three command sections:

- Set-Function
- Get-Function
- Remote control pass-through mode

NOTE: Below, “PC” represents all the control units that can send or receive the RS-232 protocol command.

Description

RS-232 Hardware Specification

ViewSonic LFD communication port on the rear side:

1. Connector type: DSUB 9-Pin Male (or 3.5 mm barrel connector)
2. Use of crossover (null modem) cable for connection
3. Pin Assignment:

Female DSUB 9-Pin

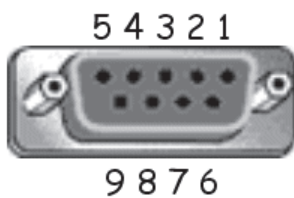

Male DSUB 9-Pin



3.5 mm barrel connector (alternative for limited space)



Pin #	Signal	Remark
1	NC	
2	RXD	Input to Display
3	TXD	Output from Display
4	NC	
5	GND	
6	NC	
7	NC	
8	NC	
9	NC	Provide +5V/2A power for external specific dongle *3.0
frame	GND	

Item	Signal	Remark
Tip	TXD	Output from Display
Ring	RXD	Input to Display
Sleeve	GND	

LAN Hardware Specification

ViewSonic LFD communication port on the rear side:

1. Connector type: 8P8C RJ45
2. Pin Assignment:

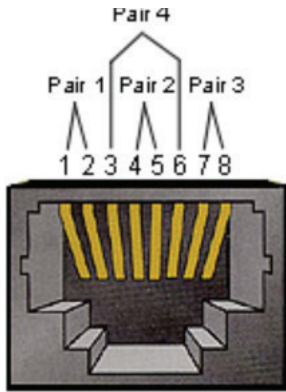

Pin #	Signal	Remark
1	TX+	Output from Display
2	TX-	Output from Display
3	RX+	Input to Display
4	BI_D3+	For 1G case
5	BI_D3-	For 1G case
6	RX-	Input to Display
7	BI_D4+	For 1G case
8	BI_D4-	For 1G case
frame	GND	

RS232 Communication Setting

- Baud Rate Select: 9600bps (fixed)
- Data bits: 8 bits (fixed)
- Parity: None (fixed)
- Stop Bits: 1(fixed)

LAN Communication Setting

- Type: Ethernet
- Protocol: TCP/IP
- Port: 5000 (fixed)
- Cross subnet: No
- Logon Credentials: No

Command Message Reference

PC sends to LFD command packet followed by “CR”. Every time PC sends control command to Display, the Display shall respond as follows:

1. If the message is received correctly it will send “+” (02Bh) followed by “CR” (00Dh)
2. If the message is received incorrectly it will send “-” (02Dh) followed by “CR” (00Dh)

Protocol

Set-Function Listing

The PC can control the Display for specific actions. The Set-Function command allows you to control the Display behavior at a remote site through the RS-232 port. The Set-Function packet format consists of 9 bytes.

Set-Function Description:

- Length:** Total Byte of Message excluding "CR"
- LFD ID** Identification for each of Display (01~98; default is 01)
ID "99" means to apply the set command for all connected displays. Under such circumstances, only ID#1 display has to reply.
The LFD ID can be set via the OSD menu for each Display.
- Command Type** Identify command type,
"s" (0x73h): Set Command
"+" (0x2Bh): Valid command Reply
"- " (0x2Dh): Invalid command Reply
- Command:** Function command code: One byte ASCII code.
- Value[1~3]:** Three bytes ASCII that defines the value.
- CR** 0x0D

Set-Function Format

Send: (Command Type="s")

Name	Length	ID	Command Type	Command	Value1	Value2	Value3	CR
Byte Count	1 Byte	2 Byte	1 Byte	1 Byte	1 Byte	1 Byte	1 Byte	1 Byte
Bytes order	1	2~3	4	5	6	7	8	9

Reply: (Command Type="+" or "-")

Name	Length	ID	Command Type	CR
Byte Count	1 Byte	2 Byte	1 Byte	1 Byte
Bytes order	1	2~3	4	5

NOTE: When PC applies command to all displays (ID=99), only the #1 set needs to reply by the name of ID=1.

Example 1: Set Brightness as 76 for Display (#02) and this command is valid

Send (Hex Format)

Name	Length	ID	Command Type	Command	Value1	Value2	Value3	CR
Hex	0x38	0x30 0x32	0x73	0x24	0x30	0x37	0x36	0x0D

Reply (Hex Format)

Name	Length	ID	Command Type	CR
Hex	0x34	0x30 0x32	0x2B	0x0D

Example 2: Set Brightness as 75 for Display (#02) and this command is NOT valid

Send (Hex Format)

Name	Length	ID	Command Type	Command	Value1	Value2	Value3	CR
Hex	0x38	0x30 0x32	0x73	0x24	0x30	0x37	0x35	0x0D

Reply (Hex Format)

Name	Length	ID	Command Type	CR
Hex	0x34	0x30 0x32	0x2D	0x0D

Set-Function Table

A. Basic Function

Set Function	Length	ID	Command	Command		Value Range (Three ASCII bytes)	Comments
			Type (ASCII)	Code (ASCII)	Code (Hex)		
Power on/ off (standby)	8		s	!	21	000: STBY 001: ON	1. The Power-on via LAN control may work only under specific mode. To see display UG for details. *3.1.1 2. "WOL by MAC address" may available as alternative.*3.2.1
Input Select	8		s	"	22	000: TV 001: AV 002: S-Video 003: YPbPr 004: HDMI1 014: HDMI2 024: HDMI3 034: HDMI4 005: DVI 006: VGA1 016: VGA2 026: VGA3 007: Slot-in PC (OPS/SDM)/HDBT 008: Internal memory 009: DP 00A: Embedded/ Main (Android)	1. No need for USB 2. For the case of two more same sources, the 2nd digital is used to indicate the extension. 3. The HEX of 00A is 30 30 41.
Brightness	8		s	\$	24	000 ~ 100 900: Bright down (-1) 901: Bright up (+1) *3.1.1	
Backlight*3.2.0	8		A	B	42	000 ~ 100	1. For Android platform whose main mode is controlled by backlight and the other sources are controlled by brightness. 2. Derived from Color calibration. *3.2.0
Power lock	8		s	4	34	000: Unlock 001: Lock	*See note in details
Volume	8		s	5	35	000 ~ 100 900: Volume down(-1) 901:Volume up(+1)	
Mute	8		s	6	36	000: OFF 001: ON (mute)	

Button lock	8		s	8	38	000: Unlock 001: Lock	*See note in details
Menu lock	8		s	>	3E	000: Unlock 001: Lock	*See note in details
Number *3.1.1	8		s	@	40	000~009	
Key Pad *3.1.1	8		s	A	41	000: UP 001: DOWN 002: LEFT 003: RIGHT 004: ENTER 005: INPUT 006: MENU/(EXIT) 007: EXIT	
Remote Control	8		s	B	42	000: Disable 001: Enable 002: Pass through	Disable: RCU will be no function Enabled: RCU controls normally Pass through: Display will bypass the RC code to connected device via the RS-232 port, but not react itself.
Restore default	8		s	~	7E	000	Recover to factory setting

NOTE:

1. Behavior at Lock Modes

Lock Mode	Behavior
Button Lock	<ol style="list-style-type: none"> Lock all buttons on the front panel and RCU, except for "Power" All the SET functions should be workable via RS-232, even the ones with according hot key in RCU like Mute,...etc.
MENU Lock	<ol style="list-style-type: none"> Lock "MENU" key of front panel and RCU The Factory and Hospitality modes should not be blocked for the model using MENU-combined key to enter these two modes. Alternative approach will be indicated separately if any limitation by model.
POWER Lock	<ol style="list-style-type: none"> Lock "POWER" key on the front and RCU. The SET_POWER on/off should be workable via RS-232, but does not mean the POWER lock will be released under this case. Can not be unlocked by reset in OSD setting Will auto AC power-on in power-lock Under power-lock, the set will not enter power saving when no PC signal and neither not turn off when no other video signals after 15 minutes.
Remote control disable	Lock the RCU keys, but keep the front panel buttons workable.

2. Wake-on-LAN by MAC address as alternative for SET Power on

(Length=126 Bytes)

6 Bytes	6 Bytes (#1)	6 Bytes (#2)	...	6 Bytes (#16)	24 Bytes
0xFF FF ... FF	MAC address	MAC address	...	MAC address	0x00 00 ... 00

B. Optional Function

Set Function	Length	ID	Command		Value Range (Three ASCII bytes)	Comments	
			Type (ASCII)	Code (ASCII) Code (Hex)			
Contrast	8		s	#	23	000 ~ 100	
Sharpness	8		s	%	25	000 ~ 100	
Color	8		s	&	26	000 ~ 100	
Tint	8		s	'	27	000 ~ 100	
Backlight On_Off	8		s	(29	000: Off 001: On	
Color mode	8		s)	29	000: Normal 001: Warm 002: Cold 003: Personal	
Surround sound	8		s	-	2D	000: OFF 001: ON	
Bass	8		s	.	2E	000 ~ 100	
Treble	8		s	/	2F	000 ~ 100	
Balance	8		s	0	30	000 ~ 100	050 is central
Picture Size	8		s	1	31	000: FULL (16:9) 001: NORMAL (4:3) 002: REAL (1:1) *3.1.0	
OSD language	8		s	2	32	000: English 001: French 002: Spanish	Could be extended for more supported languages by model
PIP-Mode	8		s	9	39	000: OFF 001: PIP(POP) 002: PBP	
PIP-Sound select	8		s	:	3A	000: Main 001: Sub	
PIP-Position	8		s	;	3B	000: Up 001: Down 002: Left 003: Right	
PIP-Input	8		s	7	37 *2.9	000: TV 001: AV 002: S-Video 003: YPbPr 004: HDMI1 014: HDMI2 024: HDMI3 034: HDMI4 005: DVI 006: VGA1 016: VGA2 026: VGA3 007: Slot-in PC (OPS/SDM)/HDBT 008: Internal memory 009: DP 00A: Embedded/Main (Android)	Value range is same as SET-Input select

Tiling-Mode	8		s	P	50	000: OFF 001: ON	(for video wall)
Tiling-Compensation	8		s	Q	51	000: OFF 001: ON	(for video wall) Bezel width compensation
Tiling-H by V Monitors	8		s	R	52	01x~09x: H 0x1~0x9: V	(for video wall) 1. 2nd digital for H monitors 2. 3rd digital for V monitors
Tiling-Position	8		s	S	53	001~025	(for Video wall) Copy the screen of Position# to identified display
Date: Year	8		s	V	56	Y17~Y99	Last 2 digits (20)17~(20)99
Date: Month	8		s	V	56	M01~M12	2 digits
Date: Day	8		s	V	56	D01~D31	2 digits
Time: Hour	8		s	W	57	H00~H23	24-hr format. 2 digits.
Time: Min	8		s	W	57	M00~M59	2 digits
Time: Sec	8		s	W	57	S00~S59	2 digits

NOTE:

1. Tiling definition of H Monitors, V Monitors, and Position

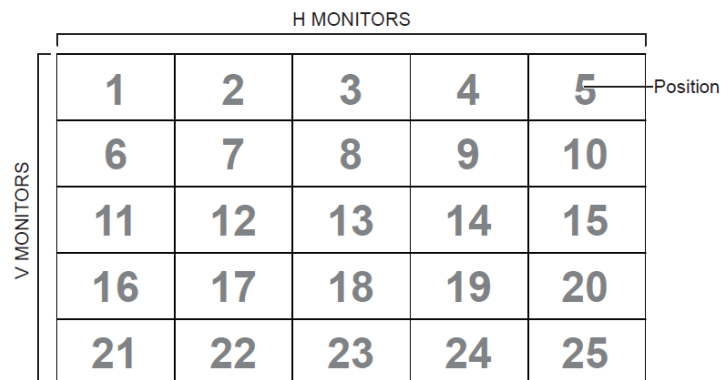

2. Set Date example

Date: 2017-3/15

Send: 0x 38 30 31 73 56 59 31 37 0D ("Y17")

Send: 0x 38 30 31 73 56 4D 30 33 0D ("M03")

Send: 0x 38 30 31 73 56 44 31 35 0D ("D15")

3. Set Time example

Time: 16:27:59

Send: 0x 38 30 31 73 57 48 31 36 0D ("H16")

Send: 0x 38 30 31 73 57 4D 32 37 0D ("M27")

Send: 0x 38 30 31 73 57 53 35 39 0D ("S59")

Get-Function Listing

The PC can interrogate the LFD for specific information. The Get-Function packet format consists of 9 bytes which is similar to the Set-Function packet structure. Note that the “Value” byte is always = 000.

Get-Function Description:

- Length:** Total Byte of Message excluding “CR”.
- TV/DS ID** Identification for each of TV/DS (01~98; default is 01).
- Command Type** Identify command type,
 “g” (0x67h) : Get Command
 “r” (0x72h) : Valid command Reply
 “-” (0x2Dh) : Invalid command Reply
- Command:** Function command code: One byte ASCII code.
- Value[1~3]:** Three bytes ASCII that defines the value.
- CR** 0x0D

Get-Function Format

Send: (Command Type=“g”)

Name	Length	ID	Command Type	Command	Value1	Value2	Value3	CR
Byte Count	1 Byte	2 Byte	1 Byte	1 Byte	1 Byte	1 Byte	1 Byte	1 Byte
Bytes order	1	2~3	4	5	6	7	8	9

Reply: (Command Type=“r” or “-”)

If the Command is valid, Command Type = “r”

Name	Length	ID	Command Type	Command	Value1	Value2	Value3	CR
Byte Count	1 Byte	2 Byte	1 Byte	1 Byte	1 Byte	1 Byte	1 Byte	1 Byte
Bytes order	1	2~3	4	5	6	7	8	9

If the Command is NOT valid, Command Type = “-”

Name	Length	ID	Command Type	CR
Byte Count	1 Byte	2 Byte	1 Byte	1 Byte
Bytes order	1	2~3	4	5

Example 1: Get Brightness from TV-05 and this command is valid. The Brightness value is 67.

Send (Hex Format)

Name	Length	ID	Command Type	Command	Value1	Value2	Value3	CR
Hex	0x38	0x30 0x35	0x67	0x62	0x30	0x30	0x30	0x0D

Reply (Hex Format)

Name	Length	ID	Command Type	Command	Value1	Value2	Value3	CR
Hex	0x38	0x30 0x35	0x72	0x62	0x30	0x36	0x37	0x0D

Example 2: Get Color from Display (#05), but the Color command is not supported by this model.

Send (Hex Format)

Name	Length	ID	Command Type	Command	Value1	Value2	Value3	CR
Hex	0x38	0x30 0x35	0x67	0x26	0x30	0x30	0x30	0x0D

Reply (Hex Format)

Name	Length	ID	Command Type	CR
Hex	0x34	0x30 0x35	0x2D	0x0D

Get-Function Table

A. Basic Function

Get Function	Length	ID	Command	Command		Response Range (Three ASCII bytes)	Comments
			Type (ASCII)	Code (ASCII)	Code (Hex)		
Get-Brightness	8		g	b	62	000 ~ 100	
Get-Backlight*3.2.0	8		a	B	42	000 ~ 100	1. For Android platform whose main mode is controlled by backlight and the other sources are controlled by brightness. 2. Derived from Color calibration. *3.2.0
Get-Volume	8		g	f	66	000 ~ 100	
Get-Mute	8		g	g	67	000: Off 001: On (muted)	
Get-Input select	8		g	j	6A	000~ 100~	1. 1st digit for signal detection: 0 means "no signal"; 1 means "signal detected" 2. 2nd & 3rd digit: See Set-function table
Get-Power status: ON/ STBY	8		g	l	6C	001: ON 000: STBY	
Get-Remote control	S		g	n	6E	000: Disable 001: Enable 002: Pass through	Get RCU mode status
Get-Power lock	8		g	o	6F	000: Unlock 001: Lock	
Get-Button lock	8		g	p	70	000: Unlock 001: Lock	
Get-Menu lock	8		g	l	6C	000: Unlock 001: Lock	
Get-ACK	8		g	z	7A	000	This command is used to test the communication link
Get-Thermal	8		g	0	30	000~100: 0~+100 deg C -01~-99: -1~-99 deg C	
Get-Operation time*3.2.0	8		g	1	31	000	1. Accumulated hours in 6-digit integer (000,001~999,999)*3.2.0 2. Can not be reset when FW update and Factory initiation*3.2.2 3. Reply in new 32-byte format*3.2.0
Get-Device name	8		g	4	34	000	Reply in new 32-byte format *3.2.0

Get-MAC address	8		g	5	35	000	(for the model with LAN) Reply in new 32-byte format*3.2.0
Get-IP address *3.2.0	8		g	6	36	000	(for the model with LAN) Reply in new 32-byte format*3.2.0
Get-Serial number *3.2.0	8		g	7	37	000	Reply in new 32-byte format *3.2.0
Get-FW version *3.2.0	8		g	8	38	000	Reply in new 32-byte format *3.2.0

NOTE:

1. Get Operation Hour example

Assumed the accumulated operation hour is 123,456 hrs

Send: 0x 38 30 31 67 31 30 30 30 0D (Get Operation hour)

Reply: 0x 32 30 31 72 31 31 32 33 34 35 36 00 00 ... 00 00 0D

2. Get Device Name example

Assumed the device name is CDE-5500

Send: 0x 38 30 31 67 34 30 30 30 0D (Get Device Name)

Reply: 0x 32 30 31 72 34 43 44 45 2D 35 35 30 30 00 00 ... 00 00 0D

Assumed the device name is "NMP-302#1"

Send: 0x 38 30 31 67 34 30 30 30 0D (Get Device Name)

Reply: 0x 32 30 31 72 34 4E 4D 50 2D 33 30 32 23 31 00 00 ...00 00 0D

3. Get MAC address example

Assumed the MAC address is 00:11:22:aa:bb:cc

Send: 0x 38 30 31 67 35 30 30 30 0D (Get MAC add)

Reply: 0x 32 30 31 72 35 30 30 31 31 32 32 61 61 62 62 63 63 00 00...00 00 0D

4. Get IP address example

Assumed the IP address is 192.168.100.2

Send: 0x 38 30 31 67 36 30 30 30 0D (Get IP address)

Reply: 0x 32 30 31 72 36 31 39 32 2E 31 36 38 2E 31 30 30 2E 32 00 00...00 00 0D

5. Get Serial number example

Assumed the Serial number is ABC180212345

Send: 0x 38 30 31 67 37 30 30 30 0D (Get Serial number)

Reply: 0x 32 30 31 72 37 41 42 43 31 38 30 32 31 32 33 34 35 00 00...00 00 0D

6. Get FW version example

Assumed the FW version is 3.02.001

Send: 0x 38 30 31 67 38 30 30 30 0D (Get FW version)

Reply: 0x 32 30 31 72 38 33 2E 30 32 2E 30 30 31 00 00...00 00 0D

B. Optional Function

Get Function	Length	ID	Command		Response Range	Comments
			Type (ASCII)	Code (ASCII) Code (Hex)		
Get-Contrast	8		g	a 61	000 ~ 100	
Get-Sharpness	8		g	c 63	000 ~ 100	
Get-Color	8		g	d 64	000 ~ 100	
Get-Tint	8		g	e 65	000 ~ 100	
Get-Backlight On_Off	8		g	h 68	000: Off 001: On	
Get-PIP mode	8		g	t 74	000: OFF 001: PIP (POP) 002: PBP	
Get-PIP input	8		g	u 75	000 ~	See Set-input select
Get-Tiling Mode	8		g	v 76	000: OFF 001: ON	(for Video wall)
Get-Tiling Compensation	8		g	w 77	000: OFF 001: ON	(for Video wall) Bezel width compensation
Get-Tiling H by V monitors	8		g	x 78	01x~09x: H monitors 0x1~0x9: V monitors	(for Video wall) 1. 2nd digital for H monitors 2. 3rd digital for V monitors
Get-Tiling position	8		g	y 79	000: OFF 001~025	(for Video wall) Copy the screen of Position# to identified display
Get-Date: Year	8		g	2 32	Y00~Y00	Last 2 digits (20)17~(20)99
Get-Date: Month	8		g	2 32	M00~M00	2 digits
Get-Date: Day	8		g	2 32	D00~M00	2 digits
Get-Time: Hour	8		g	3 33	H00~H00	24-hr format. 2 digits
Get-Time: Min	8		g	3 33	M00~M00	2 digits
Get-Time: Sec	8		g	3 33	S00~S00	2 digits

NOTE:

1. Get Date example

Assumed the current date of display#01 as below:

Date: 2017-3/15

Send: 0x 38 30 31 67 32 59 30 30 0D (Get Date:Year)

Reply: 0x 38 30 31 72 32 59 31 37 0D ("Y17")

Send: 0x 38 30 31 67 32 4D 30 30 0D (Get Date:Month)

Reply: 0x 38 30 31 72 32 4D 30 33 0D ("M03")

Send: 0x 38 30 31 67 32 44 30 30 0D (Get Date:Day)

Reply: 0x 38 30 31 72 32 44 31 35 0D ("D15")

2. Get Time example

Assumed the current time of display#01 as below:

Time: 16:27:59

Send: 0x 38 30 31 67 33 48 30 30 0D (Get Time:Hour)

Reply: 0x 38 30 31 72 33 48 31 36 0D ("H16")

Send: 0x 38 30 31 67 33 4D 30 30 0D (Get Time:Min)

Reply: 0x 38 30 31 72 33 4D 32 37 0D ("M27")

Send: 0x 38 30 31 67 33 53 30 30 0D (Get Time:Sec)

Reply: 0x 38 30 31 72 33 53 35 39 0D ("S59")

3. Get RS232 Version example

Assumed the version is 3.0.1

Send: 0x 38 30 31 67 36 30 30 30 0D (Get RS232 version)

Reply: 0x 38 30 31 72 36 33 30 31 0D ("301")

C. Auto Reply *3.2.1

The display will send out the updated data/status automatically without getting a query from the host whenever the following data/status is changed by the user through any of the available ways like: remote control unit, front keys, or touch screen.

- Power On/Off
- Input Select
- Brightness
- Backlight
- Volume
- Mute On/Off

Remote Control Pass-through Mode

When the PC sets the Display to Remote Control Pass through mode, the Display shall send a 7-byte packet (followed by “CR”) in response to remote control unit (RCU) button activation. In this mode the remote control shall have no effect on the Display function. For example: “Volume+” will not change the volume of the Display, but instead only sends the “Volume+” code to the PC over the RS-232 port.

IR Pass Through-Function format

Reply: (Command Type=“p”)

Name	Length	ID	Command Type	RCU Code1 (MSB)	RCU Code2 (LSB)	CR
Byte Count	1 Byte	2 Byte	1 Byte	1 Byte	1 Byte	1 Byte
Bytes order	1	2~3	4	5	6	7

Example 1: Remote Control Pass-through when “VOL+” key is pressed for Display (#5)

Send (Hex Format)

Name	Length	ID	Command Type	RCU Code1 (MSB)	RCU Code2 (LSB)	CR
Hex	0x36	0x30 0x35	0x70	0x31	0x30	0x0D

Key	Code (HEX)	Basic *3.1.1	Optional *3.1.1
1	01	V	
2	02	V	
3	03	V	
4	04	V	
5	05	V	
6	06	V	
7	07	V	
8	08	V	
9	09	V	
0	0A	V	
-	0B		V
RECALL (LAST)	0C		V
INFO (DISPLAY)	0D		V
	0E		
ASPECT (ZOOM, SIZE)	0F		V
VOLUME UP (+)	10	V	

VOLUME DOWN (-)	11	V	
MUTE	12	V	
CHANNEL/PAGE UP (+)/ BRIGHTNESS+	13		V
CHANNEL/PAGE DOWN (-)/ BRIGHTNESS-	14		V
POWER	15	V	
SOURCES (INPUTS)	16	V	
	17		
	18		
SLEEP	19		V
MENU	1A	V	
UP	1B	V	
DOWN	1C	V	
LEFT (-)	1D	V	
RIGHT (+)	1E	V	
OK (ENTER, SET)	1F	V	
EXIT	20	V	
	21		
	22		
	23		
	24		
	25		
	26		
	27		
	28		
	29		
	2A		
	2B		
RED ■ (F1)	2C		
GREEN ■ (F2)	2D		
YELLOW ■ (F3)	2E		
BLUE ■ (F4)	2F		

NOTE:

1. This IR-pass-through code is different from the RCU key code.
2. Special control sequence for POWER key under IR-pass through mode.
- 2-1. When Display is OFF and receives the IR POWER code: Display will turn itself on, then forward the POWER code to the host via RS-232.

- 2-2. When Display is ON and receives the IR POWER code: Display will forward the POWER code to the host via RS-232, then turn off itself.
- 2-3. When SET-POWER LOCK is enabled, the Display will not respond to POWER key pressing.
3. The VOLUME UP and VOLUME DOWN code will repeatedly output when you press and hold the keys.

Appendix

Specifications

Item	Category	Specifications		
Model	P/N.	IFP6532	IFP7532	IFP8632
	No.	VS18471	VS18472	VS18473
Screen Size		65.5"	74.5"	85.5"
Input Signal		2 x HDMI 1 x VGA 1 x Audio In 1 x LAN (RJ45) 4 x USB Type A (2.0)		
Output Signal		1 x Audio Out 1 x USB Type B		
Speaker Output		10W x 2		
RS-232		RS-232 Communication		
Power	Voltage	162V-264V +/- 10%, AC 50/60Hz		
Operating Conditions	Temperature	32° F to 104° F (0° C to 40° C)		
	Humidity	10%~90% non-condensing		
	Altitude	≤ 2,000 m		
Storage Conditions	Temperature	-4° F to 140° F (-20° C to 60° C)		
	Humidity	10%~90% non-condensing		
	Altitude	≤ 2,000 m		
Dimensions	Physical (mm)	1488 x 897 x 90	1710 x 1020 x 90	1958 x 1160 x 90
Weight	Physical (kg)	38.3	51.8	66.7
Power Consumption	On	174.4W	237.9W	313.3W
	Off	<0.5W	<0.5W	<0.5W

NOTE: Product specifications are subject to change without notice.

Display Modes

VGA Mode

Resolution	Refresh Rate (@)
1280 x 1024	60Hz
1600 x 1200	60Hz
1920 x 1080	60Hz

HDMI Mode

Resolution	Refresh Rate (@)
640 x 480	60Hz
800 x 600	60Hz
1024 x 768	60Hz
1280 x 960	60Hz
1920 x 1080	60Hz
3840 x 2160	24Hz, 25Hz, 30Hz, 50Hz, 60Hz
480p	59Hz, 60Hz
576p	50Hz
720p	50Hz, 59Hz, 60Hz
1080i	50Hz, 59Hz, 60Hz
1080p	23Hz, 24Hz, 25Hz, 29Hz, 30Hz, 50Hz, 59Hz, 60Hz

Troubleshooting

This section describes some common problems that you may experience when using the ViewBoard.

Problem or Issue	Possible Solutions
Remote Control is not working	<ol style="list-style-type: none">1. Check whether something is obstructing the display's remote control receiver.2. Check whether the batteries in the remote control are installed correctly.3. Check whether the batteries need to be replaced.
The unit turns off unexpectedly	<ol style="list-style-type: none">1. Check whether Sleep mode is enabled.2. Check if there is a power outage in your area.3. Turn on the display and see if the problem is with the signal and control system.

PC Mode

Problem or Issue	Possible Solutions
No PC signal	<ol style="list-style-type: none">1. Check the display settings.2. Check the display resolution.3. Adjust the Hs & Vs (synchronization) settings using the OSD menu.
Background streaking	<ol style="list-style-type: none">1. Choose auto adjust.2. Adjust clock and phase.
False color	<ol style="list-style-type: none">1. Check the VGA connection.2. Adjust the chroma, brightness, and contrast settings.
Unsupported format	<ol style="list-style-type: none">1. Choose auto adjust.2. Adjust clock and phase settings.

Touch Function

Problem or Issue	Possible Solutions
Touch function does not work	<ol style="list-style-type: none">1. Check that drivers are installed correctly.2. Reinstall driver(s).3. Check setup and align it.4. Check whether the touch pen is working properly.

Video Not Working Properly

Problem or Issue	Possible Solutions
No picture/ No sound	<ol style="list-style-type: none">1. Check the Power status.2. Check the signal cable.3. Check that the internal PC is installed correctly.
Picture is unclear or cuts in and out	<ol style="list-style-type: none">1. Check the signal cable.2. Check if other electronics are interrupting the signal.
Poor picture	<ol style="list-style-type: none">1. Adjust chroma, brightness, and contrast settings in the menu.2. Check the signal cable.

Audio Not Working Properly

Problem or Issue	Possible Solutions
No sound	<ol style="list-style-type: none">1. Press the Mute/Unmute button.2. Adjust the volume.3. Check the audio cable.
One speaker only	<ol style="list-style-type: none">1. Adjust the sound balance in the menu.2. Check the sound control panel settings of the computer.3. Check the audio cable. <p>NOTE: SPDIF and Audio Out only work in Embd Player, HDMI, and DisplayPort (DP) channels.</p>

Maintenance

General Precautions

- Make sure the device is turned off and the power cable is unplugged from the power outlet.
- Never spray or pour any liquid directly onto the screen or case.
- Handle the device with care, as a darker-colored device, if scuffed, may show marks more clearly than a lighter-colored device.
- Do not use the system continuously for long periods of time.

Cleaning the Screen

- Wipe the screen with a clean, soft, lint-free cloth. This removes dust and other particles.
- If the screen is still not clean, apply a small amount of non-ammonia, non-alcohol based glass cleaner onto a clean, soft, lint-free cloth; then wipe the screen.

Cleaning the Case

- Use a soft, dry cloth.
- If the case is still not clean, apply a small amount of non-ammonia, non-alcohol based, mild non-abrasive detergent onto a clean, soft, lint-free cloth, then wipe the surface.

Disclaimer

- ViewSonic® does not recommend the use of any ammonia or alcohol-based cleaners on the display screen or case. Some chemical cleaners have been reported to damage the screen and/or case of the device.
- ViewSonic® will not be liable for damage resulting from use of any ammonia or alcohol-based cleaners.

NOTE: If condensation appears between the glass and the panel, keep the display turned on until the moisture disappears.

Regulatory and Service Information

Compliance Information

This section addresses all connected requirements and statements regarding regulations. Confirmed corresponding applications shall refer to nameplate labels and relevant markings on the unit.

Industry Canada Statement

CAN ICES-3 (B)/NMB-3(B)

CE Conformity for European Countries

CE The device complies with the EMC Directive 2014/30/EU and Low Voltage Directive 2014/35/EU.

The following information is only for EU-member states:

The mark shown to the right is in compliance with the Waste Electrical and Electronic Equipment Directive 2012/19/EU (WEEE). The mark indicates the requirement NOT to dispose of the equipment as unsorted municipal waste, but use the return and collection systems according to local law.



Declaration of RoHS2 Compliance

This product has been designed and manufactured in compliance with Directive 2011/65/EU of the European Parliament and the Council on restriction of the use of certain hazardous substances in electrical and electronic equipment (RoHS2 Directive) and is deemed to comply with the maximum concentration values issued by the European Technical Adaptation Committee (TAC) as shown below:

Substance	Proposed Maximum Concentration	Actual Concentration
Lead (Pb)	0.1%	< 0.1%
Mercury (Hg)	0.1%	< 0.1%
Cadmium (Cd)	0.01%	< 0.01%
Hexavalent Chromium (Cr6 ⁺)	0.1%	< 0.1%
Polybrominated biphenyls (PBB)	0.1%	< 0.1%
Polybrominated diphenyl ethers (PBDE)	0.1%	< 0.1%
Bis (2-ethylhexyl) phthalate (DEHP)	0.1%	< 0.1%
Butyl benzyl phthalate (BBP)	0.1%	< 0.1%
Dibutyl phthalate (DBP)	0.1%	< 0.1%
Diisobutyl phthalate (DIBP)	0.1%	< 0.1%

Certain components of products as stated above are exempted under the Annex III of the RoHS2 Directives as noted below:

- Copper alloy containing up to 4% lead by weight.
- Lead in high melting temperature type solders (i.e. lead-based alloys containing 85% by weight or more lead).
- Electrical and electronic components containing lead in a glass or ceramic other than dielectric ceramic in capacitors, e.g. piezoelectronic devices, or in a glass or ceramic matrix compound.
- Lead in dielectric ceramic in capacitors for a rated voltage of 125V AC or 250V DC or higher.

Indian Restriction of Hazardous Substances

Restriction on Hazardous Substances statement (India). This product complies with the “India E-waste Rule 2011” and prohibits use of lead, mercury, hexavalent chromium, polybrominated biphenyls or polybrominated diphenyl ethers in concentrations exceeding 0.1 weight % and 0.01 weight % for cadmium, except for the exemptions set in Schedule 2 of the Rule.

Product Disposal at End of Product Life

ViewSonic® respects the environment and is committed to working and living green. Thank you for being part of Smarter, Greener Computing. Please visit the ViewSonic® website to learn more.

USA & Canada:

<https://www.viewsonic.com/us/company/green/go-green-with-viewsonic/#recycle-program>

Europe:

<http://www.viewsoniceurope.com/eu/support/call-desk/>

Taiwan:

<https://recycle.epa.gov.tw/>

Copyright Information

Copyright© ViewSonic® Corporation, 2022. All rights reserved.

Macintosh and Power Macintosh are registered trademarks of Apple Inc.

Microsoft, Windows, and the Windows logo are registered trademarks of Microsoft Corporation in the United States and other countries.

ViewSonic®, the three birds logo, OnView, ViewMatch, and ViewMeter are registered trademarks of ViewSonic® Corporation.

VESA is a registered trademark of the Video Electronics Standards Association. DPMS, DisplayPort, and DDC are trademarks of VESA.

Disclaimer: ViewSonic® Corporation shall not be liable for technical or editorial errors or omissions contained herein; nor for incidental or consequential damages resulting from furnishing this material, or the performance or use of this product.

In the interest of continuing product improvement, ViewSonic® Corporation reserves the right to change product specifications without notice. Information in this document may change without notice.

No part of this document may be copied, reproduced, or transmitted by any means, for any purpose without prior written permission from ViewSonic® Corporation.

Customer Service

For technical support or product service, see the table below or contact your reseller.

NOTE: You will need the product's serial number.

Country/ Region	Website	Country/ Region	Website
Asia Pacific & Africa			
Australia	www.viewsonic.com/au/	Bangladesh	www.viewsonic.com/bd/
中国 (China)	www.viewsonic.com.cn	香港 (繁體中文)	www.viewsonic.com/hk/
Hong Kong (English)	www.viewsonic.com/hk-en/	India	www.viewsonic.com/in/
Indonesia	www.viewsonic.com/id/	Israel	www.viewsonic.com/il/
日本 (Japan)	www.viewsonic.com/jp/	Korea	www.viewsonic.com/kr/
Malaysia	www.viewsonic.com/my/	Middle East	www.viewsonic.com/me/
Myanmar	www.viewsonic.com/mm/	Nepal	www.viewsonic.com/np/
New Zealand	www.viewsonic.com/nz/	Pakistan	www.viewsonic.com/pk/
Philippines	www.viewsonic.com/ph/	Singapore	www.viewsonic.com/sg/
臺灣 (Taiwan)	www.viewsonic.com/tw/	ประเทศไทย	www.viewsonic.com/th/
Việt Nam	www.viewsonic.com/vn/	South Africa & Mauritius	www.viewsonic.com/za/
Americas			
United States	www.viewsonic.com/us	Canada	www.viewsonic.com/us
Latin America	www.viewsonic.com/la		
Europe			
Europe	www.viewsonic.com/eu/	France	www.viewsonic.com/fr/
Deutschland	www.viewsonic.com/de/	Қазақстан	www.viewsonic.com/kz/
Россия	www.viewsonic.com/ru/	España	www.viewsonic.com/es/
Türkiye	www.viewsonic.com/tr/	Україна	www.viewsonic.com/ua/
United Kingdom	www.viewsonic.com/uk/		

Limited Warranty

ViewSonic® Smart White Board

What the warranty covers:

ViewSonic® warrants its products to be free from defects in material and workmanship during the warranty period. If a product proves to be defective in material or workmanship during the warranty period, ViewSonic® will, at its sole option, and as your sole remedy, repair or replace the product with a similar product. Replacement Product or parts may include remanufactured or refurbished parts or components. The repair or replacement unit or parts or components will be covered by the balance of the time remaining on the customer's original limited warranty and the warranty period will not be extended. ViewSonic® provides no warranty for any third-party software whether included with the product or installed by the customer, installation of any unauthorized hardware parts or components (e.g. Projector Lamps). (Please refer to: "What the warranty excludes and does not cover" section).

Who the warranty protects:

This warranty is valid only for the first consumer purchaser.

What the warranty excludes and does not cover:

- Any product on which the serial number has been defaced, modified, or removed.
- Damage, deterioration, or malfunction resulting from:
 - » Accident, misuse, neglect, fire, water, lightning, or other acts of nature, unauthorized product modification, or failure to follow instructions supplied with the product.
 - » Repair or attempted repair by anyone not authorized by ViewSonic®.
 - » Damage to or loss of any programs, data, or removable storage media.
 - » Normal wear and tear.
 - » Removal or installation of the product.
- Software or data loss occurring during repair or replacement.
- Any damage of the product due to shipment.
- Causes external to the product, such as electric power fluctuations or failure.
- Use of supplies or parts not meeting ViewSonic's specifications.
- Failure of owner to perform periodic product maintenance as stated in the User Guide.
- Any other cause which does not relate to a product defect.

- Damage caused by static (non-moving) images displayed for lengthy periods of time (also referred to as image burn-in).
- Software - Any third-party software included with the product or installed by the customer.
- Hardware/Accessories/Parts/Components – Installation of any unauthorized hardware, accessories, consumable parts or components (e.g. Projector Lamps).
- Damage to, or abuse of, the coating on the surface of the display through inappropriate cleaning as described in the product User Guide.
- Removal, installation, and set-up service charges, including wall-mounting of the product.

How to get service:

- For information about receiving service under warranty, contact ViewSonic® Customer Support (Please refer to the “Customer Service” page). You will need to provide your product’s serial number.
- To obtain warranty service, you will be required to provide: (a) the original dated sales slip, (b) your name, (c) your address, (d) a description of the problem, and (e) the serial number of the product.
- Take or ship the product, freight prepaid, in the original container to an authorized ViewSonic® service center or ViewSonic®.
- For additional information or the name of the nearest ViewSonic® service center, contact ViewSonic®.

Limitation of implied warranties:

There are no warranties, express or implied, which extend beyond the description contained herein including the implied warranty of merchantability and fitness for a particular purpose.

Exclusion of damages:

ViewSonic's liability is limited to the cost of repair or replacement of the product. ViewSonic® shall not be liable for:

- Damage to other property caused by any defects in the product, damages based upon inconvenience, loss of use of the product, loss of time, loss of profits, loss of business opportunity, loss of goodwill, interference with business relationships, or other commercial loss, even if advised of the possibility of such damages.
- Any other damages, whether incidental, consequential or otherwise.
- Any claim against the customer by any other party.
- Repair or attempted repair by anyone not authorized by ViewSonic®.

Effect of state law:

This warranty gives you specific legal rights, and you may also have other rights which vary from state to state. Some states do not allow limitations on implied warranties and/or do not allow the exclusion of incidental or consequential damages, so the above limitations and exclusions may not apply to you.

Sales outside the U.S.A. and Canada:

For warranty information and service on ViewSonic® products sold outside of the U.S.A. and Canada, contact ViewSonic® or your local ViewSonic® dealer.

The warranty period for this product in mainland China (Hong Kong, Macao, and Taiwan Excluded) is subject to the terms and conditions of the Maintenance Guarantee Card.

For users in Europe and Russia, full details of warranty provided can be found at: <http://www.viewsonic.com/eu/> under "Support/Warranty Information".



ViewSonic®